



CORECO



Vitrina expositora MURAL *MULTIDECK display*

STAR SNACK

Pag. 314-323

Vitrina expositora refrigerada serie STAR SNACK
STAR SNACK refrigerated display

Pag. 324-325

Vitrina expositora STAR SNACK CALIENTE
HOT STAR SNACK display

MURAL BAJA - *LOW MULTIDECK*

Pag. 326-327

Vitrina expositora MURAL BAJA
LOW MULTIDECK display

MURAL - *MULTIDECK*

Pag. 328-329

Gama de colores y acabados
Colour range and finishing

Pag. 330-331

Vitrina expositora MURAL ALTA EFICIENCIA
HIGH EFFICIENCY MULTIDECK display

Pag. 332-333

Vitrina expositora MURAL FONDO 655
655 MULTIDECK display

Pag. 334-335

Vitrina expositora MURAL FONDO 800
800 MULTIDECK display

Pag. 336-337

Vitrina expositora MURAL FONDO 900
900 MULTIDECK display

Pag. 338-341

Vitrina expositora MURAL FRUTAS Y VERDURAS
FRUITS & VEGETABLES MULTIDECK display

Pag. 342-345

Vitrina expositora ACERO INOX
SS MULTIDECK display

Pag. 346-347

Vitrina expositora MURAL BAJA
LOW HEIGHT MULTIDECK display

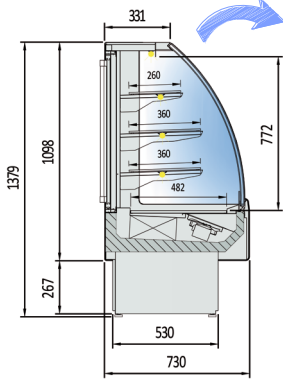

VSS-6-6-C	3.214 €
VSS-6-9-C	3.922 €
VSS-6-13-C	4.330 €
VSS-6-16-C	5.357 €
VSSB-6-6-C	3.246 €
VSSB-6-9-C	3.961 €
VSSB-6-13-C	4.373 €
VSSB-6-16-C	5.410 €



Disponible acabados de la carta NCS o RAL, incluidos en el precio estándar, excepto alto brillo y metalizados.

Available NCS or RAL letter finishes, included in the standard price, except high gloss and metallic.



mod.	rango range	largo length (mm)	fondo depth (mm)	alto height (mm)	exposición display RSA (m ²)	exposición display TDA (m ²)	volumen net volume (L)	netpuertas sliding doors (uds)	corredera hinged doors (uds)	puertas abatibles hinged doors (uds)	refrigerante refrigerant	potencia frig. frig. power (W)	consumo consumption (W)
VSS-6-6	+2°C+8°C	600	730	1380	0,74	0,55	140	0	1		R-290	483	837
VSS-6-9	+2°C+8°C	950	730	1380	1,27	0,92	231	2	0		R-290	949	1140
VSS-6-13	+2°C+8°C	1300	730	1380	1,78	1,29	322	2	0		R-290	949	1501
VSS-6-16	+2°C+8°C	1650	730	1380	2,30	1,66	417	2	0		R-290	1528	1915
VSSB-6-6	+14°C+17°C	600	730	1380	0,74	0,55	140	0	1		R-290	483	837
VSSB-6-9	+14°C+17°C	950	730	1380	1,27	0,92	231	2	0		R-290	949	1140
VSSB-6-13	+14°C+17°C	1300	730	1380	1,78	1,29	322	2	0		R-290	949	1501
VSSB-6-16	+14°C+17°C	1650	730	1380	2,30	1,66	417	2	0		R-290	1528	1915

Características técnicas y constructivas sujetas a variación sin previo aviso

Otros gases, consultar - ask for other gas
We reserve the right to change specifications without prior notice

VSS vitrina refrigerada para snack (+2°+8°)
VSSB vitrina refrigerada para chocolates (+14°+17°, 55% HR)

VSS snacks refrigerated (+2°+8°)
VSSB chocolate refrigerated (+14°+17°, 55% HR)

- Exterior fabricado en chapa de acero plastificada, lacada o inox
- Costados en ABS inyectado, 40 mm
- Interior en acero inoxidable AISI-304 18/10.
- **Cristal doble templado:** frontal, laterales y puertas
- Perfilería en aluminio anodizado
- Estantes de cristal (altura ajustable), con iluminación LED 4000K
- Opción LED 3000K (luz cálida) o ROSA, al mismo precio
- Aislamiento de poliuretano inyectado, densidad 40 Kg/m³, cero efectos ODP y GWP
- Evaporador ventilado
- Descarche automático con evaporación automática
- Condensación ventilada
- Control electrónico de temperatura
- Indicador de temperatura
- Clase climática 3 (25°C 60%)

- External finish in plastic coated steel, lacquered or stainless steel
- Sides in ABS injected, 40 mm
- Internal finish in AISI-304 18/10 stainless steel
- Tempered double glazed: front, sides and doors
- Anodised aluminium profiles
- Glass shelves, with 4000K LED lighting, adjustable height
- Optional 3000K LED (soft light) or PINK, same price
- 40 Kg/m³ density polyurethane insulation, zero ODP and GWP
- Ventilated evaporator
- Auto defrost and automatic evaporation
- Ventilated condensation
- Electronic temperature controller
- External thermometer
- Climate class 3 (25°C 60%)

Todos los modelos se pueden personalizar en decoración
Cualquier decoración incluida en el precio, excepto alto brillo y metalizado

All models can be customized in decoration
All decorations are included on price, except glossy or melic finishing

Modelo	interior epoxy NEGRO o BLANCO VSS - VSSA	KIT ruedas	230v 60Hz 115v 60Hz
Model	BLACK or WHITE epoxy interior VSS - VSSA	castors KIT	
6	156 €	240 €	consultar - consult
9	274 €	240 €	consultar - consult
13	354 €	240 €	consultar - consult
16	411 €	360 €	consultar - consult



VSS-6-6-C



VSS-6-13-C



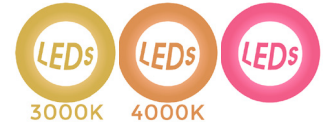
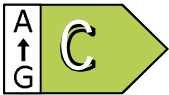

VSS

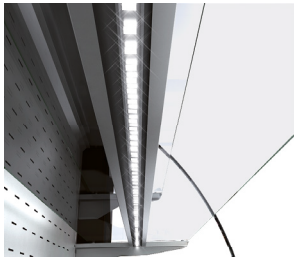

LED estantes
Shelves LED lighting

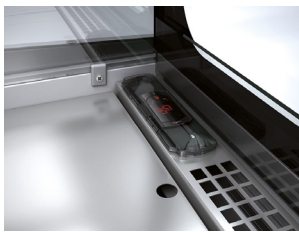

Centralita digital protegida
Electronic control protected

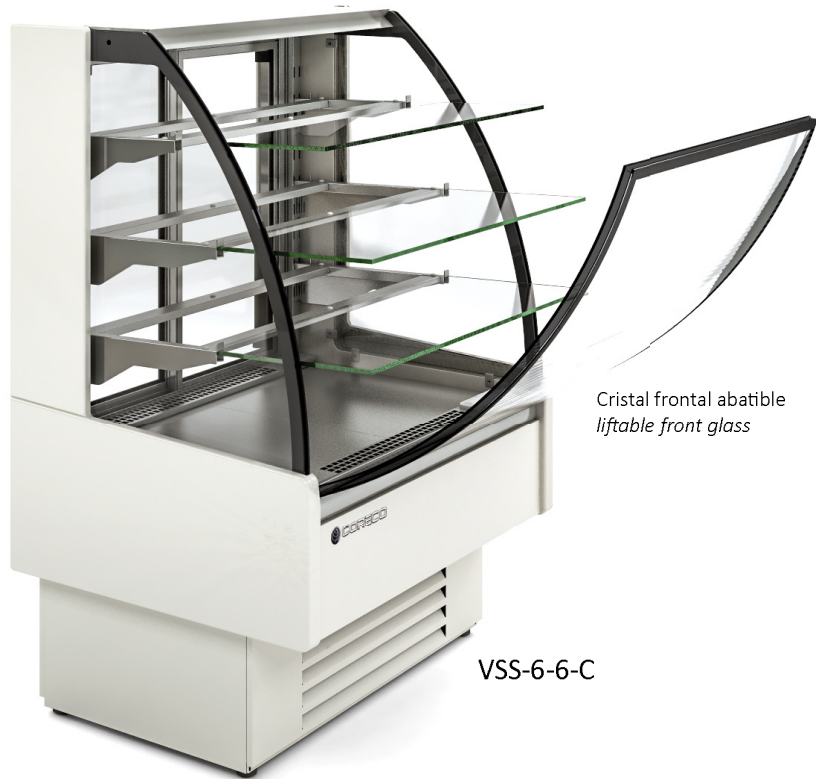

Cristal frontal abatible
liftable front glass

VSS-6-6-C



VSS-6-13-C

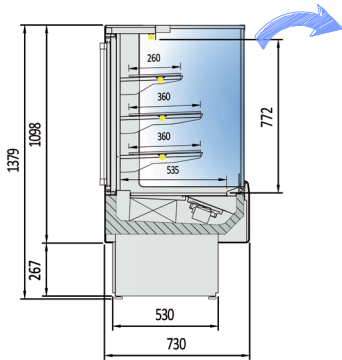

VSS-6-6-R	3.417 €
VSS-6-9-R	4.147 €
VSS-6-13-R	4.584 €
VSS-6-16-R	5.461 €
VSSB-6-6-R	3.452 €
VSSB-6-9-R	4.188 €
VSSB-6-13-R	4.629 €
VSSB-6-16-R	5.516 €



Disponibles acabados de la carta NCS o RAL, incluidos en el precio estándar, excepto alto brillo y metalizados.

Available NCS or RAL letter finishes, included in the standard price, except high gloss and metallic.



mod.	rango range	largo length (mm)	fondo depth (mm)	alto height (mm)	exposición display RSA (m²)	exposición display TDA (m²)	volumen net volume (L)	netpuertas sliding doors (uds)	corredera hinged doors (uds)	puertas abatibles hinged doors (uds)	refrigerante refrigerant	potencia frig. frig. power (W)	consumo consumption (W)
VSS-6-6	+2°C+8°C	600	730	1380	0,74	0,55	140	0	1		R-290	483	837
VSS-6-9	+2°C+8°C	950	730	1380	1,27	0,92	231	2	0		R-290	949	1140
VSS-6-13	+2°C+8°C	1300	730	1380	1,78	1,29	322	2	0		R-290	949	1501
VSS-6-16	+2°C+8°C	1650	730	1380	2,30	1,66	417	2	0		R-290	1528	1915
VSSB-6-6	+14°C+17°C	600	730	1380	0,74	0,55	140	0	1		R-290	483	837
VSSB-6-9	+14°C+17°C	950	730	1380	1,27	0,92	231	2	0		R-290	949	1140
VSSB-6-13	+14°C+17°C	1300	730	1380	1,78	1,29	322	2	0		R-290	949	1501
VSSB-6-16	+14°C+17°C	1650	730	1380	2,30	1,66	417	2	0		R-290	1528	1915

Características técnicas y constructivas sujetas a variación sin previo aviso

Otros gases, consultar - ask for other gas
We reserve the right to change specifications without prior notice

VSS vitrina refrigerada para snack (+2°+8°)
VSSB vitrina refrigerada para chocolates (+14°+17°, 55% HR)

VSS snacks refrigerated (+2°+8°)
VSSB chocolate refrigerated (+14°+17°, 55% HR)

- Exterior fabricado en chapa de acero plastificada, lacada o inox
- Costados en ABS inyectado
- Interior en acero inoxidable AISI-304 18/10.
- **Cristal doble templado:** frontal, laterales, encimera y puertas
- Perfilería en aluminio anodizado
- Estantes de cristal (altura ajustable), con iluminación LED 4000K
- Opción LED 3000K (luz cálida) o ROSA, al mismo precio
- Aislamiento de poliuretano inyectado, densidad 40 Kg/m³, cero efectos ODP y GWP
- Evaporador ventilado
- Descarche automático con evaporación automática
- Condensación ventilada
- Control electrónico de temperatura
- Indicador de temperatura
- Clase climática 3 (25°C 60%)

- External finish in plastic coated steel, lacquered or stainless steel
- Sides in ABS injected
- Internal finish in AISI-304 18/10 stainless steel
- Tempered double glazed: front, sides, worktop and doors
- Anodised aluminium profiles
- Glass shelves, with 4000K LED lighting, adjustable height
- Optional 3000K LED (soft light) or PINK, same price
- 40 Kg/m³ density polyurethane insulation, zero ODP and GWP
- Ventilated evaporator
- Auto defrost and automatic evaporation
- Ventilated condensation
- Electronic temperature controller
- External thermometer
- Climate class 3 (25°C 60%)

Todos los modelos se pueden personalizar en decoración
Cualquier decoración incluida en el precio, excepto alto brillo y metalizado

All models can be customized in decoration
All decorations are included on price, except glossy or melic finishing

Modelo	interior epoxy NEGRO o BLANCO VSS - VSSA	puerta frontal corredera*	KIT ruedas	230v 60Hz 115v 60Hz
Model	BLACK or WHITE epoxy interior VSS - VSSA	sliding front door*	castors KIT	
6	156 €	no	240 €	consultar - consult
9	274 €	199 €	240 €	consultar - consult
13	354 €	267 €	240 €	consultar - consult
16	411 €	305 €	360 €	consultar - consult

* sólo montaje en fábrica *only assembled in factory

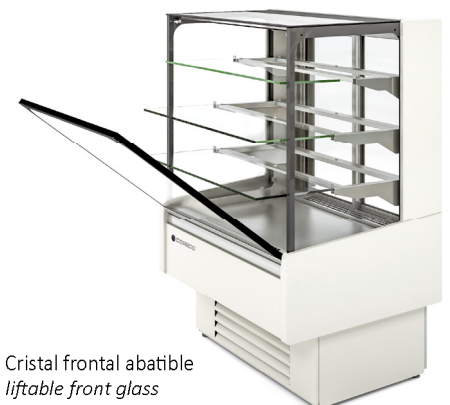

Cristal frontal abatible
liftable front glass

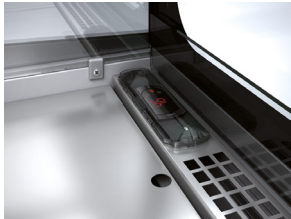
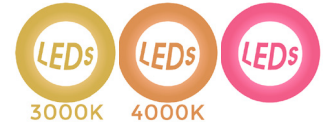
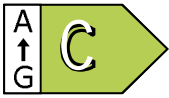

Centralita digital protegida
Electronic control



Unión cristales
Glass panels join



VSS-6-9-R



VSS-6-16-R

MURALES 9

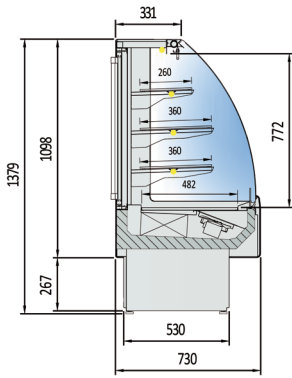

VSSA-6-6-C	3.457 €
VSSA-6-9-C	4.061 €
VSSA-6-13-C	4.501 €
VSSA-6-16-C	6.318 €
VSSAM-6-6-C	3.069 €
VSSAM-6-9-C	3.668 €
VSSAM-6-13-C	4.000 €
VSSAM-6-16-C	5.308 €

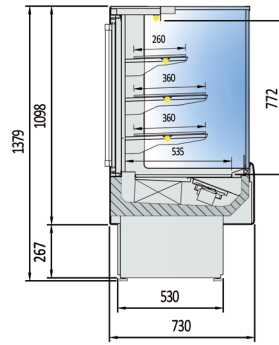

VSSA-6-6-R	3.457 €
VSSA-6-9-R	4.061 €
VSSA-6-13-R	4.501 €
VSSA-6-16-R	6.318 €

mod.	rango range	largo length (mm)	fondo depth (mm)	alto height (mm)	exposición display RSA (m²)	exposición display TDA (m²)	volumen neto net volume (L)	puertas correderas sliding doors (uds)	puertas abatibles hinged doors (uds)	refrigerante refrigerant	potencia frig. frig. power (W)	consumo consumption (W)
VSSAM-6-6	+2°C+8°C	600	730	1380	0,74	0,62	140	-	-	R-290	483	1137
VSSAM-6-9	+2°C+8°C	950	730	1380	1,27	1,03	231	-	-	R-290	949	1380
VSSAM-6-13	+2°C+8°C	1300	730	1380	1,78	1,44	322	-	-	R-290	1419	1670
VSSAM-6-16	+2°C+8°C	1650	730	1380	2,30	1,85	417	-	-	R-290	1931	2084
VSSA-6-6	+2°C+8°C	600	730	1380	0,74	0,62	140	0	1	R-290	483	1137
VSSA-6-9	+2°C+8°C	950	730	1380	1,27	1,03	231	2	0	R-290	949	1380
VSSA-6-13	+2°C+8°C	1300	730	1380	1,78	1,44	322	2	0	R-290	1419	1670
VSSA-6-16	+2°C+8°C	1650	730	1380	2,30	1,85	417	2	0	R-290	1931	2084

Características técnicas y constructivas sujetas a variación sin previo aviso

We reserve the right to change specifications without prior notice

VSSA vitrina refrigerada autoservicio puertas traseras

VSSA snacks refrigerated selfservice, rear side doors

VSSAM vitrina refrigerada autoservicio

VSSAM snacks refrigerated selfservice

- Exterior fabricado en chapa de acero plastificada, lacada o inox
- Costados en ABS inyectado
- Interior en acero inoxidable AISI-304 18/10.
- **Cristal doble templado:** laterales y puertas
- Cortina nocturna de serie
- Perfilería en aluminio anodizado
- Estantes de cristal (altura ajustable), con iluminación LED 4000K
- Opción LED 3000K (luz cálida) o ROSA, al mismo precio
- Aislamiento de poliuretano inyectado, densidad 40 Kg/m³, cero efectos ODP y GWP
- Evaporador ventilado
- Descarche automático con evaporación automática
- Condensación ventilada
- Control electrónico de temperatura
- Indicador de temperatura
- Clase climática 3 (25°C 60%) régimen M1

- External finish in plastic coated steel, lacquered or stainless steel
- Sides in ABS injected
- Internal finish in AISI-304 18/10 stainless steel
- Tempered double glazed: sides and doors
- Anodised aluminium profiles
- Night blind as standard
- Glass shelves, with 4000K LED lighting, adjustable height
- Optional 3000K LED (soft light) or PINK, same price
- 40 Kg/m³ density polyurethane insulation, zero ODP and GWP
- Ventilated evaporator
- Auto defrost and automatic evaporation
- Ventilated condensation
- Electronic temperature controller
- External thermometer
- Climate class 3 (25°C 60%) regime M1

Todos los modelos se pueden personalizar en decoración
Cualquier decoración incluida en el precio, excepto alto brillo y metalizados

All models can be customized in decoration
All decorations are included on price, except glossy or melic finishing

Modelo	interior epoxy NEGRO o BLANCO VSS - VSSA	puerta frontal corredera* (solo R)	KIT ruedas	230v 60Hz 115v 60Hz
Model	BLACK or WHITE epoxy interior VSS - VSSA	sliding front door* (only R)	castors KIT	
6	179 €	no	240 €	consultar - consult
9	286 €	199 €	240 €	consultar - consult
13	367 €	267 €	240 €	consultar - consult
16	423 €	305 €	360 €	consultar - consult

* sólo montaje en fábrica *only assembled in factory



Disponibles acabados de la carta NCS o RAL, incluidos en el precio estándar, excepto alto brillo y metalizados.

Available NCS or RAL letter finishes, included in the standard price, except high gloss and metallic.



LED estantes
Shelves LED lighting



Unión cristales
Glass panels join



Cortina nocturna de serie
Night blind as standar



VSSA-R
Opción puertas frontales
Front sliding doors
on demand

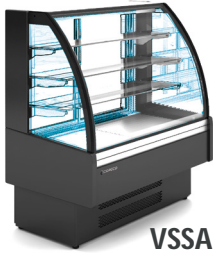

VSSA

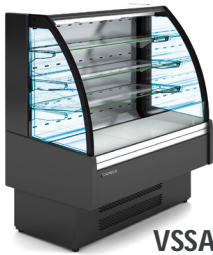

VSSAM



VSSA-6-13-R con ruedas opcionales
with optional castors

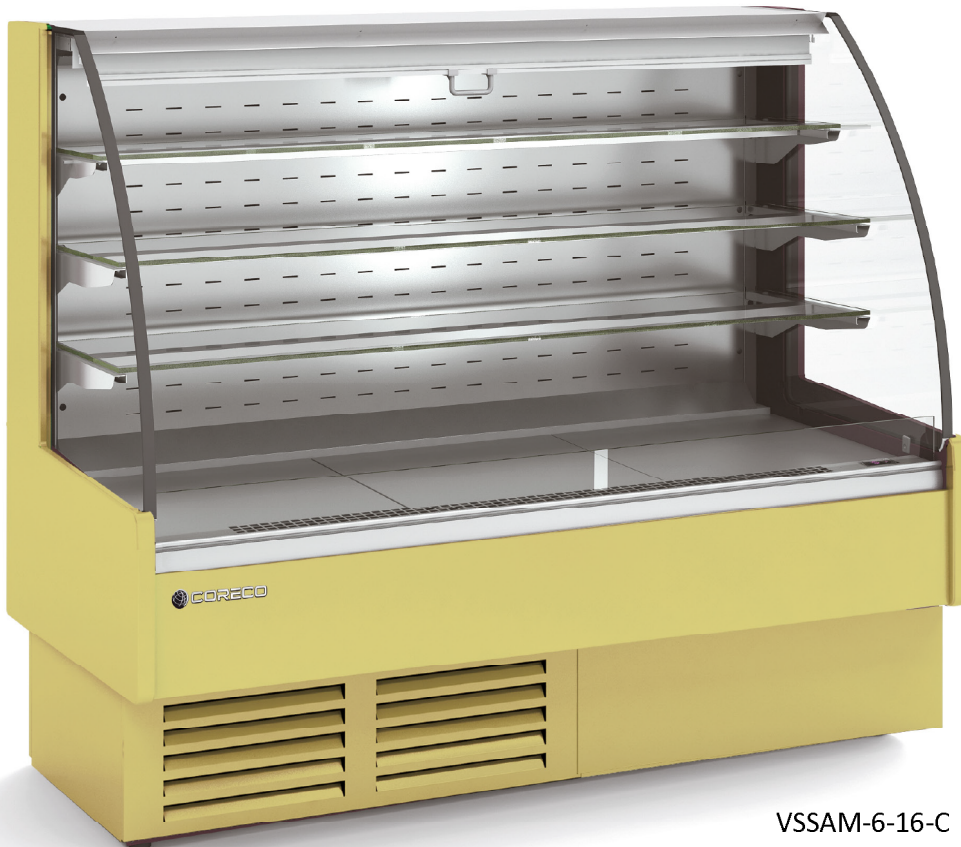

VSSAM-6-16-C

MURALES 9

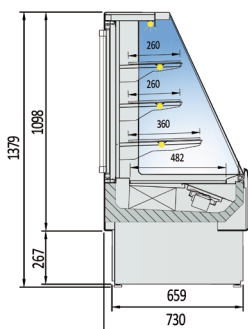

VSS-6-6-MR	3.417 €
VSS-6-9-MR	4.147 €
VSS-6-13-MR	4.584 €
VSS-6-16-MR	5.461 €
VSSA-6-6-MR	3.490 €
VSSA-6-9-MR	4.061 €
VSSA-6-13-MR	4.523 €
VSSA-6-16-MR	6.318 €

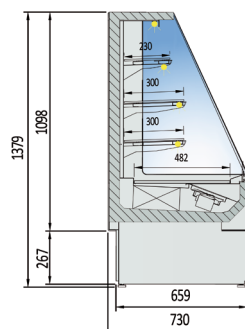

VSSAM-6-6-MR	3.373 €
VSSAM-6-9-MR	3.828 €
VSSAM-6-13-MR	4.305 €
VSSAM-6-16-MR	5.308 €

mod.	largo length (mm)	fondo depth (mm)	alto height (mm)	exposición display RSA (m ²)	exposición display TDA (m ²)	volumen neto net volume (L)	puertas corredera sliding doors (uds)	puertas abatibles hinged doors (uds)	refrigerante refrigerant	potencia frig. frig. power (W)	consumo consumption (W)
VSS-6-6-MR	560	730	1380	0,68	0,55	101	0	1	R-290	493	879
VSS-6-9-MR	910	730	1380	1,15	0,92	166	2	0	R-290	949	1198
VSS-6-13-MR	1260	730	1380	1,63	1,29	239	2	0	R-290	949	1736
VSS-6-16-MR	1610	730	1380	2,09	1,66	301	2	0	R-290	1528	1795
VSSA-6-6-MR	560	730	1380	0,68	0,62	101	0	1	R-290	483	1367
VSSA-6-9-MR	910	730	1380	1,15	1,03	166	2	0	R-290	949	1704
VSSA-6-13-MR	1260	730	1380	1,63	1,44	239	2	0	R-290	1419	2003
VSSA-6-16-MR	1610	730	1380	2,09	1,85	301	2	0	R-290	1931	2121
VSSAM-6-6-MR	560	730	1380	0,62	0,62	93	-	-	R-290	483	1367
VSSAM-6-9-MR	910	730	1380	1,06	1,03	151	-	-	R-290	949	1704
VSSAM-6-13-MR	1260	730	1380	1,5	1,44	211	-	-	R-290	1419	2003
VSSAM-6-16-MR	1610	730	1380	1,94	1,85	273	-	-	R-290	1931	2121

Características técnicas y constructivas sujetas a variación sin previo aviso

- Exterior fabricado en chapa de acero plastificada, lacada o inox
- Costados panorámicos, doble cristal con acabado negro perimetral
- Interior en acero inoxidable AISI-304 18/10.
- Cristal doble abatible
- VSSA / VSSAM cortina nocturna de serie
- Perfilera en aluminio anodizado
- Estantes de cristal (altura ajustable), con iluminación LED 4000K
- Aislamiento de poliuretano inyectado, densidad 40 Kg/m³, bajo GWP y cero efecto ODP
- Evaporador ventilado
- Descarche automático con evaporación automática
- Condensación ventilada
- Control electrónico de temperatura
- Clase climática 3 (25°C 60%HR)
- VV vitrina refrigerada para snack (+2°+8°)
- VVB vitrina refrigerada para chocolates (+14°+17°, 55% HR)
- Chasis en acero acabado epoxy
- Modelos preinstalación incorporan valvulería solenoide y expansión en R-449A, opción R-134a

We reserve the right to change specifications without prior notice

- External finish in plastic coated steel, lacquered or stainless steel
- Panoramic sides, double glazed with black perimetral finishing
- Internal finish in AISI-304 18/10 stainless steel
- Folding double glazed
- VSSA / VSSAM night blind as standar
- Anodised aluminium profiles
- Glass shelves, with 4000 K LED lighting, adjustable height
- 40 Kg/m³ density polyurethane insulation, low GWP and zero ODP effect
- Ventilated evaporator
- Auto defrost and automatic evaporation
- Ventilated condensation
- Electronic temperature controller
- Climate class 3 (25°C 60%HR)
- VV snacks refrigerated (+2°+8°)
- VVB chocolate refrigerated (+14°+17°, 55% HR)
- Chassis in epoxy finished steel
- Pre-installation models incorporate solenoid valve and expansion in R-449A, option R-134a

Modelo	interior epoxy NEGRO o BLANCO VSS - VSSA	interior NEGRO VSSAM	KIT ruedas	230v 60Hz 115v 60Hz
Model	BLACK or WHITE epoxy interior VSS - VSSA	BLACK interior VSSAM	castors KIT	
6	156 €	179 €	240 €	consultar - consult
9	274 €	286 €	240 €	consultar - consult
13	354 €	367 €	240 €	consultar - consult
16	411 €	423 €	360 €	consultar - consult



Disponibles acabados de la carta NCS o RAL, incluidos en el precio estándar, excepto alto brillo y metalizados.

Available NCS or RAL letter finishes, included in the standard price, except high gloss and metallic.



Vitrina expositora modular serie STAR SNACK, cristal CURVO
 CURVED glass STAR SNACK modular display



VSS



VSSA / VSSAM



VSSA-6-9-MR



VSS



VSSA



VSSAM

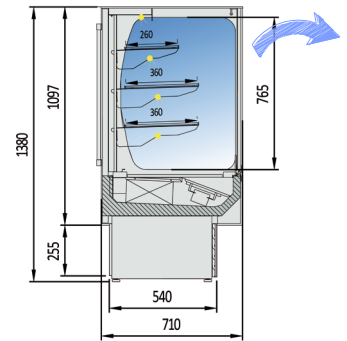
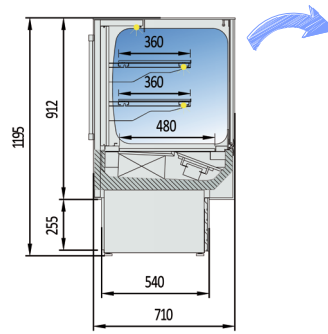
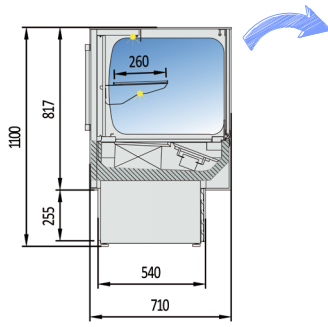

VSS-6-6-RGB	3.463 €
VSS-6-9-RGB	4.273 €
VSS-6-13-RGB	4.769 €
VSS-6-16-RGB	5.594 €

VSS-6-6-RGM	3.518 €
VSS-6-9-RGM	4.304 €
VSS-6-13-RGM	4.844 €
VSS-6-16-RGM	5.635 €

VSS-6-6-RG	3.585 €
VSS-6-9-RG	4.395 €
VSS-6-13-RG	4.886 €
VSS-6-16-RG	5.716 €

mod.	rango range	largo length (mm)	fondo depth (mm)	alto height (mm)			exposición display TDA (m²)			puertas corredera sliding doors (uds)	puertas abatibles hinged doors (uds)	refrigerante refrigerant	potencia frig. frig. power (W)	consumo consumption (W)
				RGB	RGM	RG	RGB	RGM	RG					
VSS-6-6	+2°C+8°C	600	710	1100	1195	1380	0,46	0,5	0,55	0	1	R290	483	1137
VSS-6-9	+2°C+8°C	950	710	1100	1195	1380	0,79	0,86	0,92	2	0	R290	949	1380
VSS-6-13	+2°C+8°C	1300	710	1100	1195	1380	1,11	1,2	1,29	2	0	R290	1419	1670
VSS-6-16	+2°C+8°C	1650	710	1100	1195	1380	1,44	1,56	1,66	2	0	R290	1931	2084

Características técnicas y constructivas sujetas a variación sin previo aviso

VSS vitrina refrigerada para snack (+2°+8°)

VSSB vitrina refrigerada para chocolates (+14°+17°, 55% HR)

- Exterior fabricado en chapa de acero plastificada, lacada o inox
- Costados en cristal doble templado, máxima visibilidad
- Interior en acero inoxidable AISI-304 18/10.
- **Cristal doble templado:** costados, frente, encimera y puertas
- Perfilaría en aluminio anodizado
- Estantes y encimera de cristal, con iluminación LED 4000 K
- Estantes ajustables en altura
- Opción LED 3000K (luz cálida) o ROSA, al mismo precio
- Aislamiento de poliuretano inyectado, densidad 40 Kg/m³, cero efectos ODP y GWP
- Evaporador ventilado
- Descarche automático con evaporación automática
- Condensación ventilada
- Control electrónico de temperatura
- Indicador de temperatura
- Clase climática 3 (25°C 60%) régimen M1

Todos los modelos se pueden personalizar en decoración
Cualquier decoración incluida en el precio, excepto alto brillo y metalizados

We reserve the right to change specifications without prior notice

VSS- snacks refrigerated (+2°+8°)

VSSB- chocolate refrigerated (+14°+17°, 55% HR)

- External finish in plastic coated steel, lacquered or stainless steel
- Double glazed sides, max visibility
- Internal finish in AISI-304 18/10 stainless steel
- Tempered double glazed: sides, front, top and doors
- Anodised aluminium profiles
- Glass shelves, with 4000 K LED lighting, adjustable height
- Optional 3000K LED (soft light) or PINK, same price
- 40 Kg/m³ density polyurethane insulation, zero ODP and GWP
- Ventilated evaporator
- Auto defrost and automatic evaporation
- Ventilated condensation
- Electronic temperature controller
- External thermometer
- Climate class 3 (25°C 60%) regime M1

All models can be customized in decoration
All decorations are included on price, except glossy or metallic finishing

Modelo	interior epoxy NEGRO o BLANCO VSS - VSSA	interior NEGRO VSSAM	puerta frontal corredera*	KIT ruedas	230v 60Hz 115v 60Hz
Model	BLACK or WHITE epoxy interior VSS - VSSA	BLACK interior VSSAM	sliding front door*	castors KIT	
6	156 €	179 €	no	240 €	consultar - consult
9	274 €	286 €	199 €	240 €	consultar - consult
13	354 €	367 €	267 €	240 €	consultar - consult
16	411 €	423 €	305 €	360 €	consultar - consult

* sólo montaje en fábrica *only assembled in factory



Disponibles acabados de la carta NCS o RAL, incluidos en el precio estándar, excepto alto brillo y metalizados.

Available NCS or RAL letter finishes, included in the standard price, except high gloss and metallic.



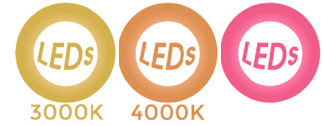
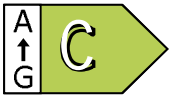

VSS-6-13-RGM



VSS-6-9-RG



VSS-6-9-RGB

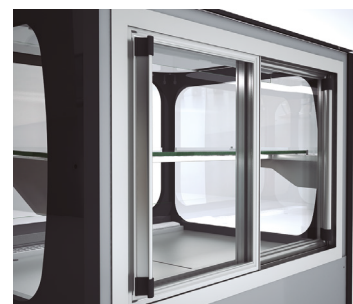

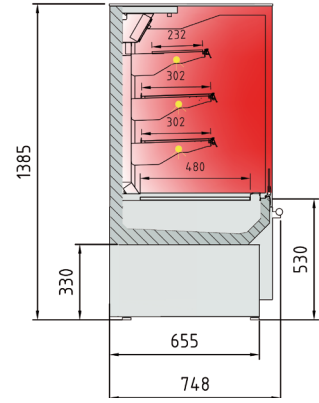
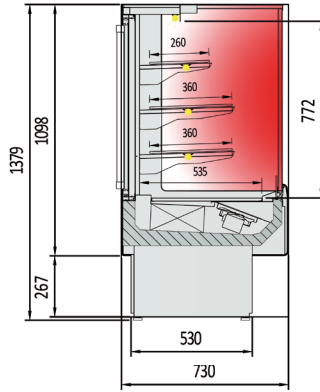
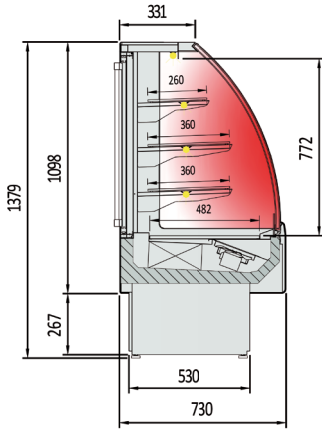

VSS-6HE-6-C	2.858 €
VSS-6HE-9-C	3.555 €
VSS-6HE-13-C	3.928 €
VSS-6HE-16-C	4.748 €

VSS-6HE-6-R	2.930 €
VSS-6HE-9-R	3.586 €
VSS-6HE-13-R	4.003 €
VSS-6HE-16-R	4.795 €

VSSAM-6HE-9	3.553 €
VSSAM-6HE-13	4.024 €

mod.	largo length (mm)	fondo depth (mm)	alto height (mm)	área estantes shelves area (m²)	exposición display TDA (m²)	volumen neto net volume (L)	puertas corredera sliding doors (uds)	puertas abatibles hinged doors (uds)	consumo consumption (W)	rango range
VSS-6HE-6	600	730	1380	0,74	0,55	140	0	1	1026	+60°C +70°C 45%- 50% HR
VSS-6HE-9	950	730	1380	1,27	0,92	231	2	0	1657	+60°C +70°C 45%- 50% HR
VSS-6HE-13	1300	730	1380	1,78	1,29	322	2	0	2482	+60°C +70°C 45%- 50% HR
VSS-6HE-16	1650	730	1380	2,30	1,66	417	2	0	3308	+60°C +70°C 45%- 50% HR
VSSHA-6HE-9	915	750	1390	0,92	0,92	231	0	0	1683	+60°C +70°C 45%- 50% HR
VSSHA-6HE-13	1265	750	1390	1,29	1,29	322	0	0	2430	+60°C +70°C 45%- 50% HR

Características técnicas y constructivas sujetas a variación sin previo aviso

We reserve the right to change specifications without prior notice

- Exterior fabricado en chapa de acero plastificada, lacada o inox
- Costados en ABS inyectado
- Interior en acero inoxidable AISI-304 18/10.
- **Cristal doble templado:** laterales, frente y puertas
- VSSAM sólo cristal recto
- Perfiles en aluminio anodizado
- Aislamiento de poliuretano inyectado, densidad 40 Kg/m³, cero efectos ODP y GWP
- Estantes en alambre de acero, altura regulable
- Cajón con dispositivo humidificador
- Control electrónico de temperatura
- Indicador de temperatura

Todos los modelos se pueden personalizar en decoración
Cualquier decoración incluida en el precio, excepto alto brillo y metalizados

- External finish in plastic coated steel, lacquered or stainless steel
- Sides in ABS injected
- Internal finish in AISI-304 18/10 stainless steel
- **Tempered double glazed:** sides, front and doors
- VSSAM only straight glass, nor curved
- Anodised aluminium profiles
- 40 Kg/m³ density polyurethane insulation, zero ODP and GWP
- Shelves made of steel wire, adjustable height
- Humidifier drawer
- Electronic temperature controller
- External thermometer
- Climate class 3 (25°C 60%) regime M1

All models can be customized in decoration
All decorations are included on price, except glossy or melic finishing

Modelo	interior NEGRO VSS - VSSA	interior NEGRO VSSAM	KIT ruedas	230v 60Hz 115v 60Hz
Model	BLACK interior VSS - VSSA	BLACK interior VSSAM	castors KIT	
6	156 €	179 €	240 €	consultar - consult
9	274 €	286 €	240 €	consultar - consult
13	354 €	367 €	240 €	consultar - consult
16	411 €	423 €	360 €	consultar - consult



Disponibles acabados de la carta NCS o RAL, incluidos en el precio estándar, excepto alto brillo y metalizados.

Available NCS or RAL letter finishes, included in the standard price, except high gloss and metallic.

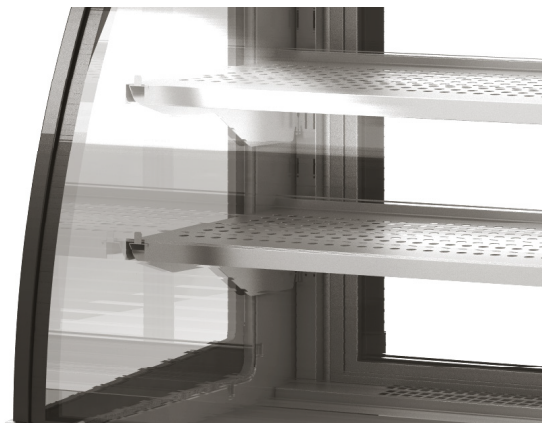

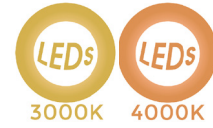

VSS-6HE-9-C



VSSAM-6HE-9

MURALES 9



CPRO-60 2.388



CPRO-90 2.589 €



CPROH-60 2.509 €



CPROH-90 2.708 €

mod.	Largo Length (mm)	Alto Height (m ²)	Fondo Depth (uds)	exposición display RSA (m ²)	exposición display TDA (m ²)	Capacidad Capacity (L)	Estantes Shelves (°C)	potencia frig. frig. power (W)	consumo consumption (W)	refrigerante refrigerant
CPRO-60	640	1540	640	0,55	0,44	200	2	967	1435	R290
CPRO-90	915	1540	640	0,72	0,59	288	2	1263	1911	R290
CPROH-60	640	1965	640	0,93	0,69	332	4	967	1487	R290
CPROH-90	915	1965	640	1,5	0,91	523	4	1263	1961	R290

características técnicas y constructivas sujetas a variación sin previo aviso

we reserve the right to change specifications whitout prior notice

- Exterior en acero plastificado
- Interior en acero acabado epoxy blanco
- Diseñados para bebidas y productos envasados
- Estantes de acero pintado epoxy, regulables en altura, con portaprecios
- Costados con doble cristal templado
- De serie: Luz horizontal, vertical y cortina nocturna
- Iluminación LED
- Control digital de temperatura y descarches
- Evaporación y condensación ventilada
- Aislamiento de poliuretano inyectado, libre CFCs, densidad 40 Kg/m³
- Evaporación automática del agua de descarche
- Clase climática 3 (25°C 60%HR) régimen M1, temperatura producto -1/5°C UNE EN ISO 23953-2:2015
- Tensión monofásica 230V 50/60 Hz

- Exterior in plasticised steel
- Epoxy finished steel interior white
- Designed for beverages and packaged
- Plastic coated steel shelves adjustable in height, with price holders
- Sides tempered double glazed
- Standard: horizontal and vertical lighting and night curtain
- LED lighting
- Digital temperature control and defrost
- Ventilated evaporation and condensation
- Insulation: Polyurethane, CFC, density 40 Kg / m³
- Automatic evaporation of defrost water
- Climatic class 3 (25°C 60%HR) regime M1, product temperature -1/5°C UNE EN ISO 23953-2:2015
- Voltage 230V 50/60 Hz

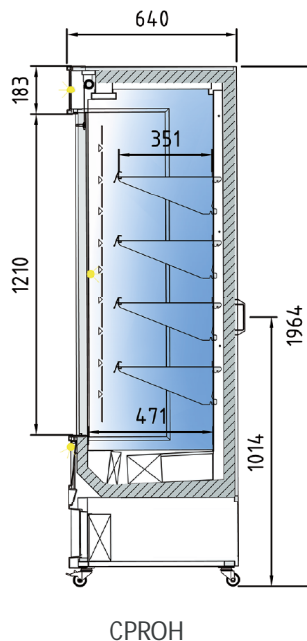
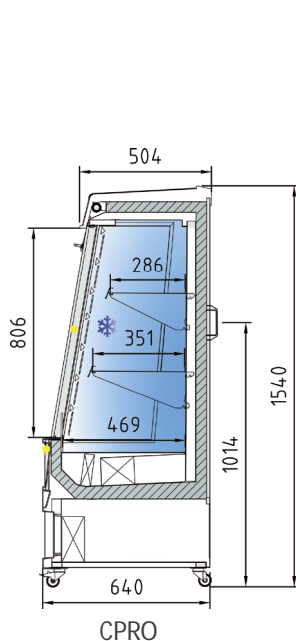

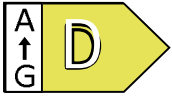

CPROH-60



CPRO-90

MURALES 9

DECORACION SOLO FRANJA SUPERIOR e INFERIOR:

- Costados en ABS inyectado color Gris, Blanco o Negro
- Franjas decorativas en chapa plastificada color Gris, Blanco o Negro
- Franjas decorativa, disponible en 22 acabados sin incremento de precio o en acabado según tabla NCS con incremento de precio

FRONT STRIPS DECOR:

- Injected ABS sides, colors Grey, White or Black
- Plasticized front strips in colors Grey, White or Black
- Front strips, available in 22 finishes included in price or in NCS scale finishing with extra price

ESTANDAR



Total exterior GRIS 7024
Total grey exterior 7024

EXCEPCIONES - SPECIAL PRICE



Total exterior blanco o negro o incluido en precio estándar
Total exterior white or black included on standard price

ACABADOS ESTANDAR - STANDARD FINISHING

Decoración exterior total blanco, negro o gris RAL 7024 incluido en el precio
Total exterior decoration white, black or gray RAL 7024 included on price



				
INOX- Stainless Steel	GRIS RAL 7024	BLANCO - RAL-9003	NEGRO- RAL-9005	PANTONE 5865
				
HAYA- beech	RAL-2011	PANTONE 7606C	PANTONE 543C	
				
NOGAL- walnut	RAL-1018	RAL-3015	PANTONE 5523C	
				
ROBLE- oak	RAL-6001	PANTONE 2298C	PANTONE 7604C	
				
WENGUE	RAL-3020	RAL-5023	RAL-401C	
				
	PANTONE 4725C	RAL-5003	PANTONE 2408C	

S: serigrafiado- screen printed **P:** plastificado- plastic coated **L:** lacado- lacquered

DECORACION FRONTAL:

- Incremento sobre el precio base
- Costados en ABS inyectado color Gris, Blanco o Negro
- Franjas decorativas y góndola disponibles según tablas de colores y precios correspondientes

FRONT DECOR:

- Extra price over standar
- Injected ABS sides, colors Grey, White or Black
- Front strips and base available by color scales with corresponding extra price



DECORACION TOTAL:

- Incremento sobre el precio base
- Costados, franjas decorativas y góndola disponibles según tablas de colores y precios correspondientes

TOTAL DECOR:

- Extra price over standar
- Sides, front strips and base available by color scales with corresponding extra price



Modelos CD exterior e interior inox
CDI modelos SS exterior and interior



Acabados, decoraciones y opciones

Colour range, finishing and options

ILUMINACION INTERIOR

- Iluminación LED 4000 K estándar, opción LED 3000K o ROSA, al mismo precio
- Franja horizontal estándar, modelos con puerta incluyen franja vertical en los laterales del marco encastrado de serie (excepto puertas correderas)
- Iluminación en estantes con incremento de precio



INTERIOR LIGHTING

- **LED 4000 K standard lighting**, optional LED 3000K or red fresh included in price
- Standard horizontal LED strip, vertical strip included in built frame on models with doors (except sliding doors units)
- Shelves lighting with extra price

COSTADOS - SIDES

ESTANDAR - STANDARD

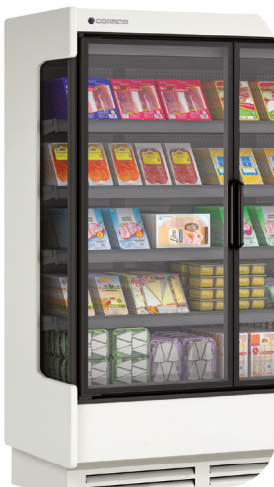

Costado **ABS** de serie
ABS side as standard

CERRADO -

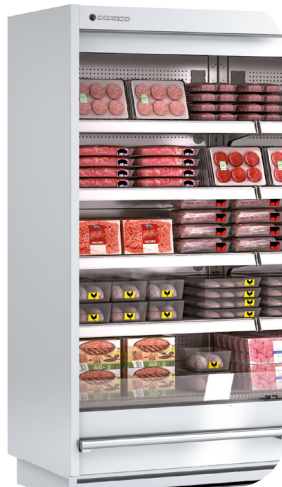

Costado **LC** al mismo precio
LC side, no extra price

VISION



Costado **LV** al mismo precio
LV side, no extra price

PANORAMICO - PANORAMIC



Costado **LE** +933 €
LE

OTROS OPCIONALES - OTHER OPTIONS

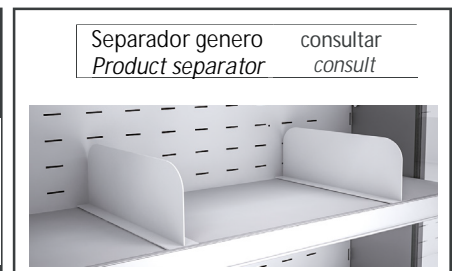
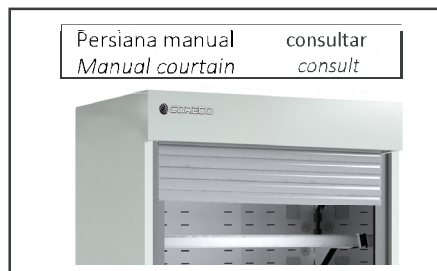
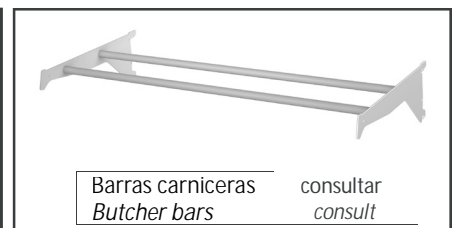
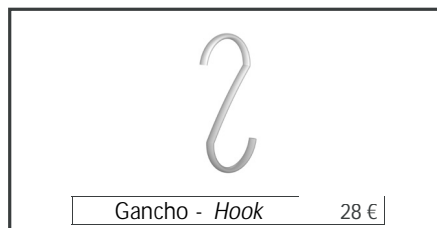
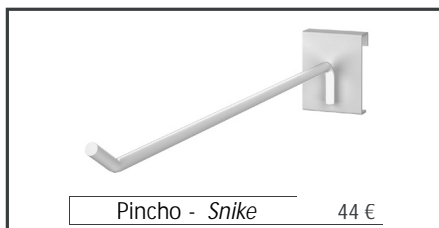

Mod.	Fronte metacrilato x estante <i>Methacrylate front x shelf</i>
CDG3 / CDS3 06	30 €
CDG3 / CDS3 09	35 €
CDG3 / CDS3 12	38 €
CDG3 / CDS3 15	40 €
CDG3 / CDS3 18	56 €
CDG3 / CDS3 25	66 €
CDG3 31	80 €

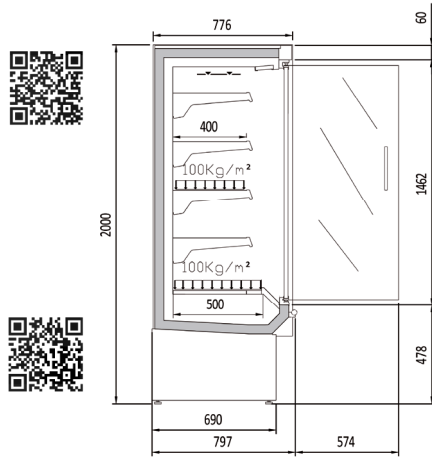

CHDG1 09 M1	5.692 €
CHDG1 12 M1	5.745 €

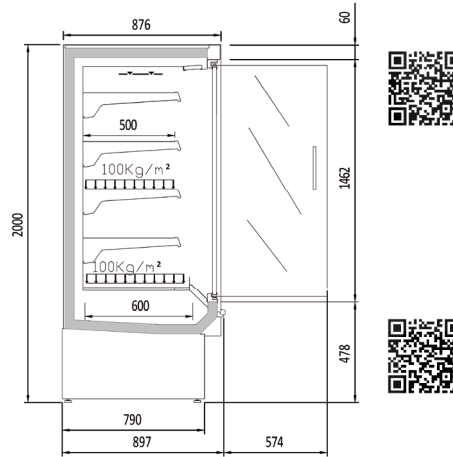

CHDG3 09 M1	5.789 €
CHDG3 12 M1	5.842 €

Modelo	Longitud (con costados)	Área estantes refrigerados m ²	Superficie total exposición (TDA)	Volumen neto (L)	Estantes	Puertas	Potencia frigorífica	Consumo Kw/24h	Clase Energética	Refrigerante
Model	Length (with sides)	Refrigerated shelf area m ²	Total display area (TDA)	Net volume (L)	Shelves uds	Doors uds	Cooling capacity W	Power Kw/24h	Energy Class	Refrigerant
CHDG1 09 M1	998	2,00	1,15	549	4	2	496- 1018W	4,55	B	R-290
CHDG1 12 M1	1310	2,68	1,5	714	4	2	497- 1018W	5,4	B	R-290
CHDG3 09 M1	998	2,47	1,17	659	4	2	498- 1018W	4,55	B	R-290
CHDG3 12 M1	1310	3,30	1,52	857	4	2	499- 1018W	5,4	B	R-290

características técnicas y constructivas sujetas a variación sin previo aviso

we reserve the right to change specifications whitout prior notice

- Puertas abatibles de vidrio con serigrafía, apertura hasta 93° y bloqueo de cierre manual. Autocierre por barra de torsión
- Evaporador ventilado con recubrimiento EPOXI anticorrosión
- Estantes regulables en altura y ángulo, con portaprecios de 40 mm incluidos
- Desescarche natural del evaporador
- Bandeja de evaporación automática
- Control electrónico
- Iluminación LED 24v 4000k
- Temperatura de producto, según EN-ISO-23953:
M1: -1°+5°C, apropiado para carnes.
- Clase climática 3 (25°C, 60 H.R)
- Aislamiento de poliuretano inyectado, densidad 40kg/m3 bajo GWP y cero efecto ODP

CARACTERÍSTICAS PARTICULARES:

- Lateral exterior panorámico incluido en el precio
- Exterior lacado o inox incluido en el precio
- Interior blanco 9003 o negro 9005 incluido en el precio
- Compresor inverter de velocidad variable
- Ventiladores electrónicos
- Válvula de expansión electrónica
- Nivel sonoro modelo CHDG 09: 36 db
- Nivel sonoro modelo CHDG 12: 45 db
- Temperatura de producto, según EN-ISO-23953: M1:-1°+5°C

- Frameless hinged doors with complete glazed frontal with serigraphy, max opening 93° with manual blocking closure. Self-closing by torsion bar
- Ventilated evaporator EPOXY with anticorrosive coating
- Adjustable shelves in height and angle, with 40 mm price holders included
- Natural defrost of evaporator
- Automatic evaporation tray
- Electronic control
- 24v LED 4000k lighting
- Product temperature, according to EN-ISO-23953:
M1: -1°+5°C, suitable for meat
- Climatic class 3 (25°C, 60 H.R)
- Injected polyurethane insulation, density 40kg / m3 low GWP and zero ODP effect

PARTICULAR CHARACTERISTICS:

- Panoramic exterior side included in price
- Lacquered or stainless exterior included in price
- Interior white 9003 or black 9005 included in price
- Variable speed inverter compressor
- Electronic fans
- Electronic expansion valve
- Sound level model CHDG 09: 36 db
- Sound level model CHDG 12: 45 db
- Product temperature, according to EN-ISO-23953: M1: -1°+5°C,



Vitrina expositora MURAL CON PUERTAS ALTA EFICIENCIA

HIGH EFFICIENCY MULTIDECK WITH DOORS display

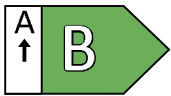

máxima eficiencia energética



max energy efficiency



componentes
baja presión sonora



low noise
components

ventiladores
electrónicos

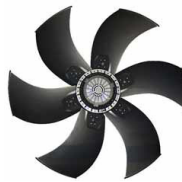

electronic
fans

compresor
inverter



Inverter
compressor



3000K



4000K



Led vertical incluido
en precio
Vertical led included
in price

CHDG1 12 HE

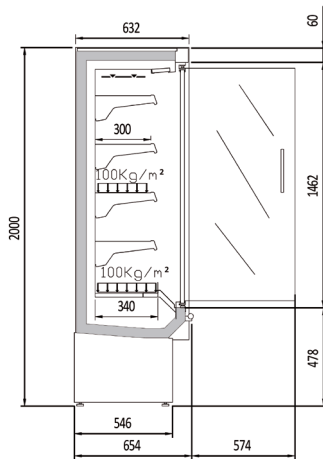

CDGO 06 M	3.841 €
CDGO 09 M	4.309 €
CDGO 12 M	4.360 €
CDGO 15 M	5.473 €
CDGO 18 M	5.608 €
CDGO 25 M	6.633 €
CDGO 31 M	9.994 €

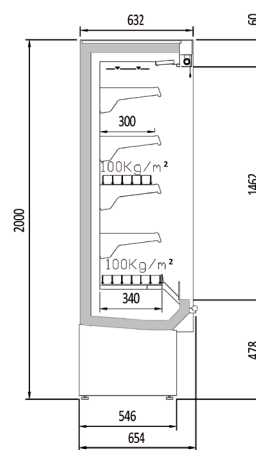

CDSO 06 M	2.827 €
CDSO 09 M	3.352 €
CDSO 12 M	3.740 €
CDSO 15 M	4.613 €
CDSO 18 M	5.168 €
CDSO 25 M	5.740 €

Modelo	Longitud (con costados)	Área estantes refrigerados m ²	Superficie total exposición (TDA)	Volumen neto (L)	Estantes	Puertas	Potencia frigorífica	Consumo nominal	Refrigerante
Model	Length (with sides)	Refrigerated shelf area m ²	Total display area (TDA)	Net volume (L)	Shelves	Doors	Cooling capacity	Nominal Power	Refrigerant
MODELOS CON PUERTAS / MODELS WITH DOORS									
CDGO 06 M1-M2	685	1,00	0,73	255	4	1	555	1132	R-290
CDGO 09 M1-M2	998	1,50	1,11	392	4	2	1192	1494	R-290
CDGO 12 M1-M2	1310	2,00	1,46	510	4	2	1192	1508	R-290
CDGO 15 M1-M2	1623	2,50	1,77	668	8	2	1419	1635	R-290
CDGO 18 M1-M2	1935	3,00	2,19	784	8	3	1528	1945	R-290
CDGO 25 M1-M2	2560	4,00	2,9	1020	8	4	2384	2612	R-290
CDGO 31 M1-M2	3185	5,00	3,54	1336	16	4	2838	3377	R-290
MODELOS SIN PUERTAS / MODELS WITHOUT DOORS									
CDSO 06 M1-M2	685	1,00	0,84	255	4	-	1192	1382	R-290
CDSO 09 M1-M2	998	1,50	1,27	392	4	-	1528	1713	R-290
CDSO 12 M1-M2	1310	2,00	1,64	510	4	-	1931	1885	R-290
CDSO 15 M1-M2	1623	2,50	2,03	668	8	-	2384	2368	R-290
CDSO 18 M1-M2	1935	3,00	2,5	784	8	-	3056	3026	R-290
CDSO 25 M1-M2	2560	4,00	3,2	1020	8	-	3862	3770	R-290

características técnicas y constructivas sujetas a variación sin previo aviso

we reserve the right to change specifications without prior notice

- Modelo CDS: Cortina de noche manual y frente cuba inferior de metacrilato
- Modelo CDG: Puertas abatibles de vidrio con serigrafía, apertura hasta 93° y bloqueo de cierre manual. Autocierre por barra de torsión
- Costados de 30 mm, de serie en ABS color gris RAL 7024, opcional CERRADO al mismo precio
- Costado panorámico (doble cristal) opcional con incremento de precio
- Interior: Blanco RAL 9003 o negro RAL 9005 incluidos en el precio
- Exterior: Blanco RAL 9003, negro RAL 9005 o gris RAL 7024 incluidos en el precio
- Decoración opcional, según costados, sólo frontal (franja superior e inferior) o total a elegir en los colores disponibles
- Evaporador ventilado con recubrimiento EPOXI anticorrosión
- Estantes regulables en altura y ángulo, con portaprecios de 40 mm incluidos
- Desescarche natural del evaporador con bandeja de evaporación automática
- Control electrónico
- Ventiladores electromecánicos, opcional electrónicos (consultar)
- Iluminación LED 24v 4000k
- Temperatura de producto, según EN-ISO-23953:
 - M1: -1°+5°C, apropiado para carnes.
 - M2: -1°+7°C, apropiado para lácteos, delis y embutidos
- Clase climática 3 (25°C, 60 H.R)
- Modelos preinstalación incorporan valvulería solenoide y expansión en R-449A, opción R-134a (consultar otros refrigerantes)
- Aislamiento de poliuretano inyectado, densidad 40kg/m3 bajo GWP y cero efecto ODP

- CDS Model: Manual night blind and and inferior exposition deck perspex
- CDG Model: Frameless hinged doors with complete glazed frontal with serigraphy, max opening 93° with manual blocking closure. Self-closing by torsion bar
- 30 mm sides, standard in gray ABS RAL 7024, optional BLIND at the same price
- Panoramic side (double glass) optional with price increase
- Interior: white RAL 9003 or black RAL 9005 included in price
- Exterior: white RAL 9003, black RAL 9005 or grey RAL 7024 included in price
- Optional decoration, depending on the sides, only front (upper and lower strip) or total to choose in the available colors.
- Ventilated evaporator EPOXY with anticorrosive coating
- Natural defrost of evaporator with automatic evaporation tray
- Electronic control
- Electromechanic fans, on demand, electronics (consult)
- 24v LED 4000k lighting
- Product temperature, according to EN-ISO-23953:
 - M1: -1°+5°C, suitable for meat
 - M2: -1°+7°C, suitable for dairy products, delis and sausages
- Climatic class 3 (25°C, 60 H.R)
- Pre-installation models incorporate solenoid and expansion valves in R-449A, option R-134a (consult other refrigerants)
- Injected polyurethane insulation, density 40kg / m3 low GWP and zero ODP effect

Modelo	decoración FRONTAL FRONT decor		decoración TOTAL FRONT decor		Juego costados cerrados	Juego costados panorámico	Tope estante metacrilato	Paragolpes tubo inox	Iluminación LED X nivel estantes	estante vidrio	Pre Instalación
Model	normal	alto brillo glossy	normal	alto brillo glossy	Blind sides SET	Panoramic sides SET	Methacrylate shelf stopper	Stainless steel bumper	LED Lighting X shelves level	glass shelf	Remote Unit
					LC	LE	ud	ud		ud	
CDG / CDS 06	248 €	consultar	441 €	consultar	0 €	933 €	30 €	41 €	39 €	215 €	-166 €
CDG / CDS 09	258 €	consultar	449 €	consultar	0 €	933 €	35 €	59 €	58 €	215 €	-223 €
CDG / CDS 12	272 €	consultar	456 €	consultar	0 €	933 €	38 €	75 €	75 €	215 €	-275 €
CDG / CDS 15	282 €	consultar	462 €	consultar	0 €	933 €	40 €	88 €	80 €	215 €	-286 €
CDG / CDS 18	302 €	consultar	469 €	consultar	0 €	933 €	56 €	108 €	112 €	215 €	-327 €
CDG / CDS 25	312 €	consultar	475 €	consultar	0 €	933 €	66 €	137 €	181 €	215 €	-530 €
CDG 31	356 €	consultar	480 €	consultar	0 €	933 €	80 €	175 €	187 €	215 €	-733 €

Precio para opcionales montados en fábrica, no repuestos. Otros gases o voltajes, consultar

Price for factory-assembled options, not as spare parts. Other gases or voltages, consult

Clase Eficiencia Energé-
tica *
Energy Efficiency Class *

Vitrina expositora MURAL FONDO 655

655 MULTIDECK display



CDG



CDS



ESTANDAR
Total exterior GRIS 7024
Total grey exterior 7024



EXCEPCIONES - SPECIAL PRICE
Total exterior blanco o negro, incluido en precio estándar
Total exterior white or black included on standard price



Led vertical incluido
en precio
Vertical led included
in price

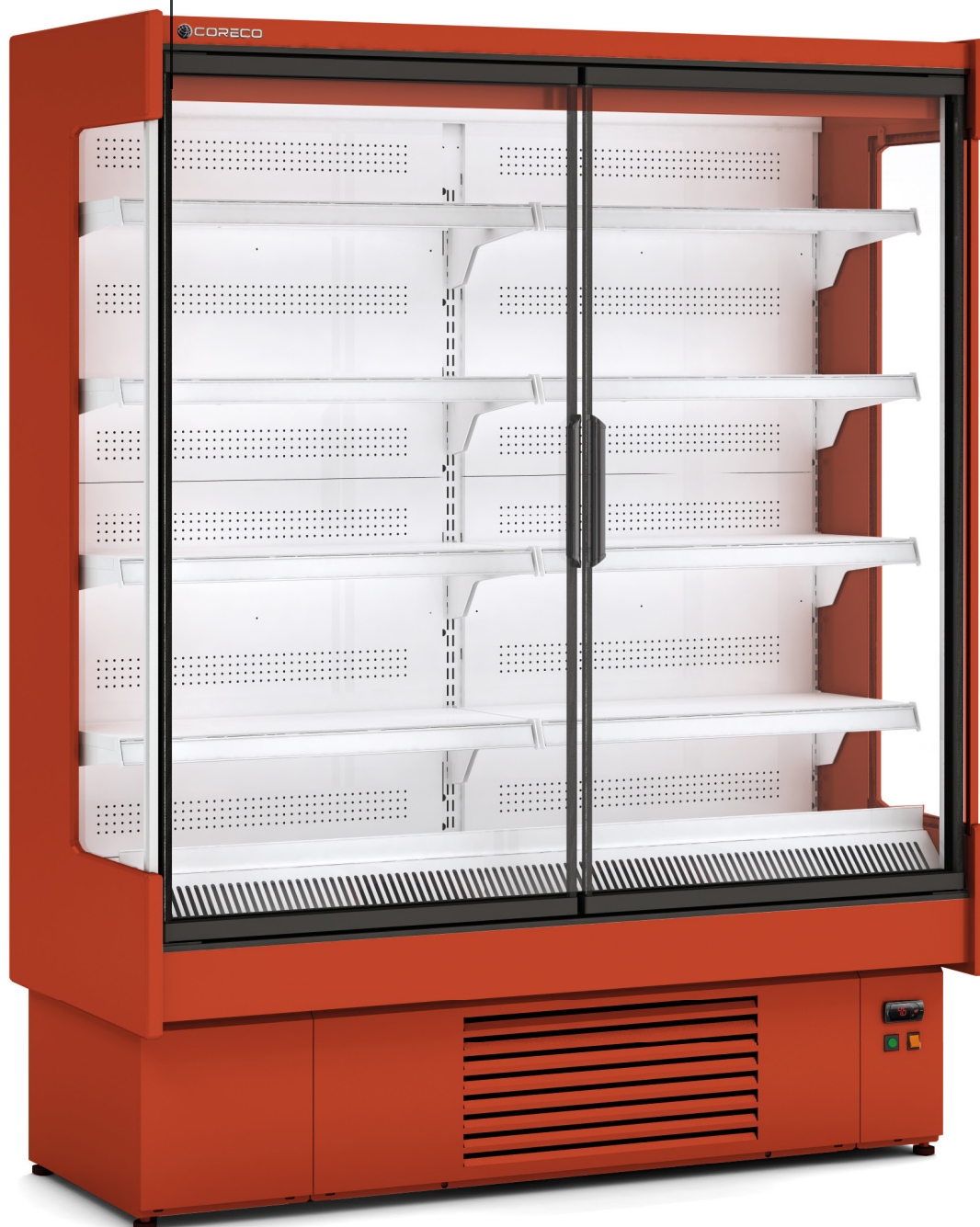

CDG0 125

Acabado exterior decoración total opcional
Total exterior finishing as extra

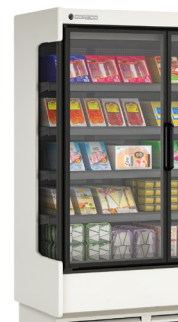

Lateral ABS de serie
ABS side as standard



Lateral CERRADO -LC opcional
incluido en el precio
BLIND side -LC on demand
included on price



Lateral PANORÁMICO -LE opcional
con incremento
PANORAMIC side -LE on demand
with extra price

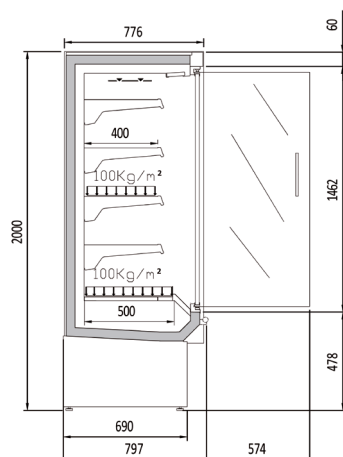

CDG1 06 M	3.960 €
CDG1 09 M	4.394 €
CDG1 12 M	4.447 €
CDG1 15 M	5.558 €
CDG1 18 M	5.715 €
CDG1 25 M	6.860 €
CDG1 31 M	10.236 €

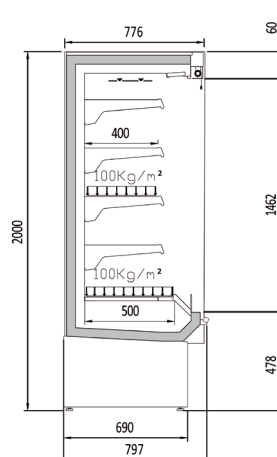

CDS1 06 M	2.954 €
CDS1 09 M	3.485 €
CDS1 12 M	3.879 €
CDS1 15 M	4.926 €
CDS1 18 M	5.272 €
CDS1 25 M	5.826 €

Modelo	Longitud (con costados)	Área estantes refrigerados m²	Superficie total exposición (TDA)	Volumen neto (L)	Estantes	Puertas	Potencia frigorífica	Consumo nominal	Refrigerante
Model	Length (with sides)	Refrigerated shelf area m²	Total display area (TDA)	Net volume (L)	Shelves	Doors	Cooling capacity	Nominal Power	Refrigerant
MODELOS CON PUERTAS / MODELS WITH DOORS									
CDG1 06 M1-M2	685	1,34	0,76	357	4	1	555	1132	R-290
CDG1 09 M1-M2	998	2,00	1,15	549	4	2	1192	1494	R-290
CDG1 12 M1-M2	1310	2,68	1,5	714	4	2	1192	1508	R-290
CDG1 15 M1-M2	1623	3,34	1,83	935	8	2	1419	1635	R-290
CDG1 18 M1-M2	1935	4,01	2,24	1098	8	3	1528	1945	R-290
CDG1 25 M1-M2	2560	5,35	2,94	1428	8	4	2384	2612	R-290
CDG1 31 M1-M2	3185	6,69	3,6	1870	16	4	2838	3377	R-290
MODELOS SIN PUERTAS / MODELS WITHOUT DOORS									
CDS1 06 M1-M2	685	1,00	0,87	357	4	-	1192	1382	R-290
CDS1 09 M1-M2	998	1,50	1,32	549	4	-	1528	1713	R-290
CDS1 12 M1-M2	1310	2,00	1,72	714	4	-	1931	1885	R-290
CDS1 15 M1-M2	1623	2,50	2,1	935	8	-	2384	2368	R-290
CDS1 18 M1-M2	1935	3,00	2,58	1098	8	-	3056	3026	R-290
CDS1 25 M1-M2	2560	4,00	3,38	1428	8	-	3862	3770	R-290

características técnicas y constructivas sujetas a variación sin previo aviso

we reserve the right to change specifications without prior notice

- Modelo CDS: Cortina de noche manual y frente cuba inferior de metacrilato
- Modelo CDG: Puertas abatibles de vidrio con serigrafía, apertura hasta 93° y bloqueo de cierre manual. Autocierre por barra de torsión
- Costados de 30 mm, de serie en ABS color gris RAL 7024, opcional CERRADO al mismo precio
- Costado panorámico (doble cristal) opcional con incremento de precio
- Interior: Blanco RAL 9003 o negro RAL 9005 incluidos en el precio
- Exterior: Blanco RAL 9003, negro RAL 9005 o gris RAL 7024 incluidos en el precio
- Decoración opcional, según costados, sólo frontal (franja superior e inferior) o total a elegir en los colores disponibles
- Evaporador ventilado con recubrimiento EPOXI anticorrosión
- Estantes regulables en altura y ángulo, con portaprecios de 40 mm incluidos
- Desescarche natural del evaporador con bandeja de evaporación automática
- Control electrónico
- Ventiladores electromecánicos, opcional electrónicos (consultar)
- Iluminación LED 24v 4000k
- Temperatura de producto, según EN-ISO-23953:
 - M1: -1°+5°C, apropiado para carnes.
 - M2: -1°+7°C, apropiado para lácteos, delis y embutidos
- Clase climática 3 (25°C, 60 H.R)
- Modelos preinstalación incorporan valvulería solenoide y expansión en R-449A, opción R-134a (consultar otros refrigerantes)
- Aislamiento de poliuretano inyectado, densidad 40kg/m3 bajo GWP y cero efecto ODP

- CDS Model: Manual night blind and and inferior exposition deck perspex
- CDG Model: Frameless hinged doors with complete glazed frontal with serigraphy, max opening 93° with manual blocking closure. Self-closing by torsion bar
- 30 mm sides, standard in gray ABS RAL 7024, optional BLIND at the same price
- Panoramic side (double glass) optional with price increase
- Interior: white RAL 9003 or black RAL 9005 included in price
- Exterior: white RAL 9003, black RAL 9005 or grey RAL 7024 included in price
- Optional decoration, depending on the sides, only front (upper and lower strip) or total to choose in the available colors.
- Ventilated evaporator EPOXY with anticorrosive coating
- Natural defrost of evaporator with automatic evaporation tray
- Electronic control
- Electromechanic fans, on demand, electronics (consult)
- 24v LED 4000k lighting
- Product temperature, according to EN-ISO-23953:
 - M1: -1°+5°C, suitable for meat
 - M2: -1°+7°C, suitable for dairy products, delis and sausages
- Climatic class 3 (25°C, 60 H.R)
- Pre-installation models incorporate solenoid and expansion valves in R-449A, option R-134a (consult other refrigerants)
- Injected polyurethane insulation, density 40kg / m3 low GWP and zero ODP effect

Modelo	decoración FRONTAL FRONT decor		decoración TOTAL FRONT decor		Juego costados cerrados	Juego costados panorámico	Tope estante metacrilato	Paragolpes tubo inox	Iluminación LED X nivel estantes	estante vidrio	Pre Instalación
	normal	alto brillo glossy	normal	alto brillo glossy	Blind sides SET	Panoramic sides SET	Methacrylate shelf stopper	Stainless steel bumper	LED Lighting X shelves level	glass shelf	Remote Unit
CDG / CDS 06	248 €	consultar	441 €	consultar	0 €	933 €	30 €	41 €	39 €	215 €	-166 €
CDG / CDS 09	258 €	consultar	449 €	consultar	0 €	933 €	35 €	59 €	58 €	215 €	-223 €
CDG / CDS 12	272 €	consultar	456 €	consultar	0 €	933 €	38 €	75 €	75 €	215 €	-275 €
CDG / CDS 15	282 €	consultar	462 €	consultar	0 €	933 €	40 €	88 €	80 €	215 €	-286 €
CDG / CDS 18	302 €	consultar	469 €	consultar	0 €	933 €	56 €	108 €	112 €	215 €	-327 €
CDG / CDS 25	312 €	consultar	475 €	consultar	0 €	933 €	66 €	137 €	181 €	215 €	-530 €
CDG 31	356 €	consultar	480 €	consultar	0 €	933 €	80 €	175 €	187 €	215 €	-733 €

Precio para opcionales montados en fábrica, no repuestos. Otros gases o voltajes, consultar

Price for factory-assembled options, not as spare parts. Other gases or voltages, consult

Vitrina expositora MURAL FONDO 800

800 MULTIDECK display



CDG

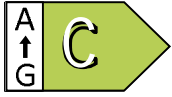

CDS



3000K



4000K



ESTANDAR

Total exterior GRIS 7024
Total grey exterior 7024



EXCEPCIONES - SPECIAL PRICE

Total exterior blanco o negro, incluido en precio estándar
Total exterior white or black included on standard price



Led vertical incluido en precio
Vertical led included in price



CDG1 18 M1-M2 - LE
Decoración exterior, opcional
Optional exterior decoration

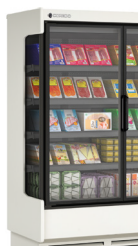

Lateral ABS de serie
ABS side as standard

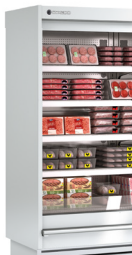

Lateral CERRADO -LC opcional
incluido en el precio
BLIND side -LC on demand
included on price



Lateral PANORÁMICO -LE opcional
con incremento
PANORAMIC side -LE on demand
with extra price

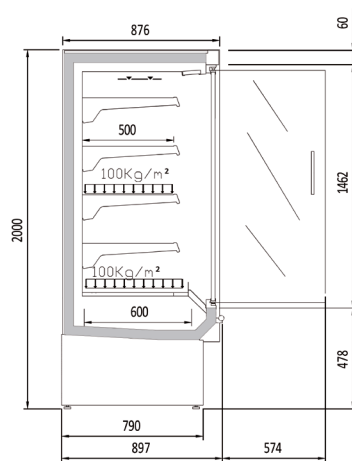

CDG3 06 M	4.158 €
CDG3 09 M	4.491 €
CDG3 12 M	4.544 €
CDG3 15 M	5.653 €
CDG3 18 M	5.844 €
CDG3 25 M	6.914 €
CDG3 31 M	11.035 €

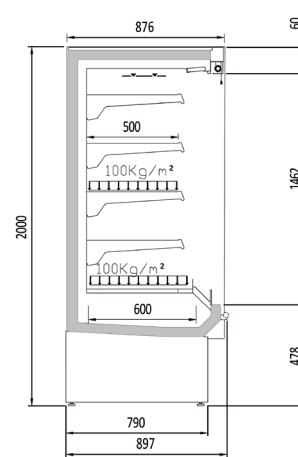

CDS3 06 M	3.030 €
CDS3 09 M	3.529 €
CDS3 12 M	3.928 €
CDS3 15 M	5.191 €
CDS3 18 M	5.398 €
CDS3 25 M	5.900 €

Modelo	Longitud (con costados)	Área estantes refrigerados m ²	Superficie total exposición (TDA)	Volumen neto (L)	Estantes	Puertas	Potencia frigorífica	Consumo nominal	Refrigerante
Model	Length (with sides)	Refrigerated shelf area m ²	Total display area (TDA)	Net volume (L)	Shelves	Doors	Cooling capacity	Nominal Power	Refrigerant
MODELOS CON PUERTAS / MODELS WITH DOORS									
CDG3 06 M1-M2	685	1,65	0,78	428	4	1	555	1132	R-290
CDG3 09 M1-M2	998	2,47	1,17	659	4	2	1192	1494	R-290
CDG3 12 M1-M2	1310	3,30	1,52	857	4	2	1192	1508	R-290
CDG3 15 M1-M2	1623	4,12	1,88	1122	8	2	1419	1635	R-290
CDG3 18 M1-M2	1935	4,95	2,29	1317	8	3	1528	1945	R-290
CDG3 25 M1-M2	2560	6,60	2,99	1714	8	4	2384	2612	R-290
CDG3 31 M1-M2	3185	8,25	3,71	2244	16	4	2838	3377	R-290
MODELOS SIN PUERTAS / MODELS WITHOUT DOORS									
CDS3 06 M1-M2	685	1,65	0,9	428	4	-	1192	1382	R-290
CDS3 09 M1-M2	998	2,47	1,34	659	4	-	1528	1713	R-290
CDS3 12 M1-M2	1310	3,30	1,75	857	4	-	1931	1885	R-290
CDS3 15 M1-M2	1623	4,12	2,16	1122	8	-	2384	2368	R-290
CDS3 18 M1-M2	1935	4,95	2,63	1317	8	-	3056	3026	R-290
CDS3 25 M1-M2	2560	6,60	3,44	1714	8	-	3862	3770	R-290

características técnicas y constructivas sujetas a variación sin previo aviso

we reserve the right to change specifications without prior notice

- Modelo CDS: Cortina de noche manual y frente cuba inferior de metacrilato
- Modelo CDG: Puertas abatibles de vidrio con serigrafía, apertura hasta 93° y bloqueo de cierre manual. Autocierre por barra de torsión
- Costados de 30 mm, de serie en ABS color gris RAL 7024, opcional CERRADO al mismo precio
- Costado panorámico (doble cristal) opcional con incremento de precio
- Interior: Blanco RAL 9003 o negro RAL 9005 incluidos en el precio
- Exterior: Blanco RAL 9003, negro RAL 9005 o gris RAL 7024 incluidos en el precio
- Decoración opcional, según costados, sólo frontal (franja superior e inferior) o total a elegir en los colores disponibles
- Evaporador ventilado con recubrimiento EPOXI anticorrosión
- Estantes regulables en altura y ángulo, con portaprecios de 40 mm incluidos
- Desescarche natural del evaporador con bandeja de evaporación automática
- Control electrónico
- Ventiladores electromecánicos, opcional electrónicos (consultar)
- Iluminación LED 24v 4000k
- Temperatura de producto, según EN-ISO-23953:
 - M1: -1°+5°C, apropiado para carnes.
 - M2: -1°+7°C, apropiado para lácteos, delis y embutidos
- Clase climática 3 (25°C, 60 H.R)
- Modelos preinstalación incorporan valvulería solenoide y expansión en R-449A, opción R-134a (consultar otros refrigerantes)
- Aislamiento de poliuretano inyectado, densidad 40kg/m3 bajo GWP y cero efecto ODP

- CDS Model: Manual night blind and and inferior exposition deck perspex
- CDG Model: Frameless hinged doors with complete glazed frontal with serigraphy, max opening 93° with manual blocking closure. Self-closing by torsion bar
- 30 mm sides, standard in gray ABS RAL 7024, optional BLIND at the same price
- Panoramic side (double glass) optional with price increase
- Interior: white RAL 9003 or black RAL 9005 included in price
- Exterior: white RAL 9003, black RAL 9005 or grey RAL 7024 included in price
- Optional decoration, depending on the sides, only front (upper and lower strip) or total to choose in the available colors.
- Ventilated evaporator EPOXY with anticorrosive coating
- Natural defrost of evaporator with automatic evaporation tray
- Electronic control
- Electromechanic fans, on demand, electronics (consult)
- 24v LED 4000k lighting
- Product temperature, according to EN-ISO-23953:
 - M1: -1°+5°C, suitable for meat
 - M2: -1°+7°C, suitable for dairy products, delis and sausages
- Climatic class 3 (25°C, 60 H.R)
- Pre-installation models incorporate solenoid and expansion valves in R-449A, option R-134a (consult other refrigerants)
- Injected polyurethane insulation, density 40kg / m3 low GWP and zero ODP effect

Modelo	decoración FRONTAL FRONT decor		decoración TOTAL FRONT decor		Juego costados cerrados	Juego costados panorámico	Tope estante metacrilato	Paragolpes tubo inox	Iluminación LED X nivel estantes	estante vidrio	Pre Instalación
	normal	alto brillo glossy	normal	alto brillo glossy	LC	LE	ud	ud	consultar	ud	Remote Unit
CDG / CDS 06	248 €	consultar	441 €	consultar	0 €	933 €	30 €	41 €	39 €	215 €	-166 €
CDG / CDS 09	258 €	consultar	449 €	consultar	0 €	933 €	35 €	59 €	58 €	215 €	-223 €
CDG / CDS 12	272 €	consultar	456 €	consultar	0 €	933 €	38 €	75 €	75 €	215 €	-275 €
CDG / CDS 15	282 €	consultar	462 €	consultar	0 €	933 €	40 €	88 €	80 €	215 €	-286 €
CDG / CDS 18	302 €	consultar	469 €	consultar	0 €	933 €	56 €	108 €	112 €	215 €	-327 €
CDG / CDS 25	312 €	consultar	475 €	consultar	0 €	933 €	66 €	137 €	181 €	215 €	-530 €
CDG 31	356 €	consultar	480 €	consultar	0 €	933 €	80 €	175 €	187 €	215 €	-733 €

Precio para opcionales montados en fábrica, no repuestos. Otros gases o voltajes, consultar

Price for factory-assembled options, not as spare parts. Other gases or voltages, consult

Vitrina expositora MURAL FONDO 900

900 MULTIDECK display



CDG

CDS

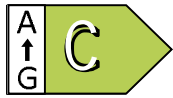

ESTANDARD

Total exterior GRIS 7024
Total grey exterior 7024

EXCEPCIONES - SPECIAL PRICE

Total exterior blanco o negro, incluido en precio estándar
Total exterior white or black included on standard price

Led vertical incluido en precio
Vertical led included in price



CDG3 25 M1-M2 - LE

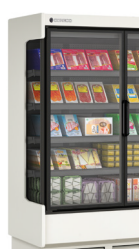

Lateral ABS de serie
ABS side as standard



Lateral CERRADO -LC opcional
incluido en el precio
BLIND side -LC on demand
included on price



Lateral PANORÁMICO -LE opcional
con incremento
PANORAMIC side -LE on demand
with extra price

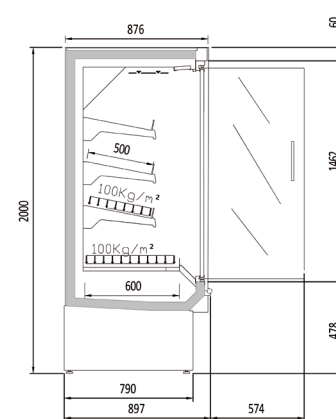
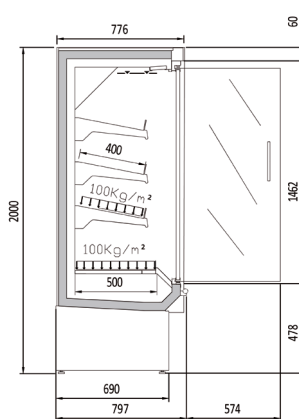
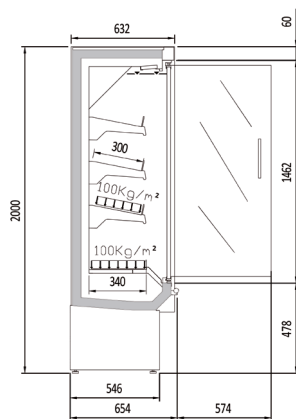

CDG0 06 H1	3.801 €
CDG0 09 H1	4.393 €
CDG0 12 H1	4.445 €
CDG0 15 H1	5.557 €
CDG0 18 H1	5.717 €
CDG0 25 H1	6.762 €
CDG0 31 H1	9.880 €

CDG1 06 H1	3.953 €
CDG1 09 H1	4.436 €
CDG1 12 H1	4.490 €
CDG1 15 H1	5.567 €
CDG1 18 H1	5.769 €
CDG1 25 H1	6.824 €
CDG1 31 H1	10.220 €

CDG3 06 H1	4.154 €
CDG3 09 H1	4.542 €
CDG3 12 H1	4.597 €
CDG3 15 H1	5.571 €
CDG3 18 H1	5.912 €
CDG3 25 H1	6.994 €
CDG3 31 H1	10.649 €

Modelo	Longitud (con costados)	Área estantes refrigerados m ²			Superficie total exposición (TDA)			Volumen neto (L)			Estantes	Puertas	Potencia frigorífica	Consumo nominal	Refrigerante
Model	Length (with sides)	Refrigerated shelf area m ²			Total display area (TDA)			Net volume (L)			Shelves	Doors	Cooling capacity	Nominal Power	Refrigerant
	(mm)	Fondo/Depth 0	Fondo/Depth 1	Fondo/Depth 3	Fondo/Depth 0	Fondo/Depth 1	Fondo/Depth 3	Fondo/Depth 0	Fondo/Depth 1	Fondo/Depth 3	Uds	Uds. Units	(W)	(W)	
CDG 06 H1	685	0,81	1,08	1,33	0,72	0,75	0,77	239	336	403	3	1	555	1132	R290
CDG 09 H1	998	1,21	1,62	2,00	1,09	1,13	1,15	368	516	619	3	2	1192	1494	R290
CDG 12 H1	1310	1,61	2,16	2,66	1,44	1,48	1,5	480	671	805	3	2	1192	1528	R290
CDG 15 H1	1623	2,02	2,70	3,33	1,75	1,81	1,86	628	879	1055	6	2	1419	1635	R290
CDG 18 H1	1935	2,42	3,24	4,00	2,17	2,22	2,27	737	1032	1238	6	3	1528	1945	R290
CDG 25 H1	2560	3,23	4,33	5,33	2,88	2,92	2,97	959	1342	1611	6	4	2384	2612	R290
CDG 31 H1	3185	4,03	5,41	6,65	3,52	3,58	3,69	1256	1758	2110	12	4	2838	3377	R290

características técnicas y constructivas sujetas a variación sin previo aviso

we reserve the right to change specifications without prior notice

- Puertas abatibles de vidrio con serigrafía, apertura hasta 93° y bloqueo de cierre manual. Autocierre por barra de torsión
- Costados de 30 mm, de serie en ABS color gris RAL 7024, opcional CERRADO al mismo precio
- Costado panorámico (doble cristal) opcional con incremento de precio
- Interior: Blanco RAL 9003 o negro RAL 9005 incluidos en el precio
- Exterior: Blanco RAL 9003, negro RAL 90005 o gris RAL 7024 incluidos en el precio
- Decoración opcional, según costados, sólo frontal (franja superior e inferior) o total a elegir en los colores disponibles
- Espejo en la parte superior y tope frontal metacrilato en los estantes, de serie
- Evaporador ventilado con recubrimiento EPOXI anticorrosión
- Estantes regulables en altura y ángulo, con portaprecios de 40 mm incluidos
- Desescarche natural del evaporador con bandeja de evaporación automática
- Control electrónico
- Ventiladores electromecánicos, opcional electrónicos (consultar)
- Iluminación LED 24v 4000k
- Temperatura de producto, según EN-ISO-23953:
 - H1: +1°+10°C, apropiado para frutas y verduras
- Clase climática 3 (25°C, 60 H.R)
- Modelos preinstalación incorporan valvulería solenoide y expansión en R-449A, opción R-134a (consultar otros refrigerantes)
- Aislamiento de poliuretano inyectado, densidad 40kg/m³ bajo GWP y cero efecto ODP

- Frameless hinged doors with complete glazed frontal with serigraphy, max opening 93° with manual blocking closure. Self-closing by torsion bar
- 30 mm sides, standard in gray ABS RAL 7024, optional BLIND at the same price
- Panoramic side (double glass) optional with price increase
- Interior: white RAL 9003 or black RAL 9005 included in price
- Exterior: white RAL 9003, black RAL 9005 or grey RAL 7024 included in price
- Optional decoration, depending on the sides, only front (upper and lower strip) or total to choose in the available colors.
- Mirror on the top and methacrylate front stop on the shelves, standard
- Ventilated evaporator EPOXY with anticorrosive coating
- Natural defrost of evaporator with automatic evaporation tray
- Electronic control
- Electromechanic fans
- 24v LED 4000k lighting
- Product temperature, according to EN-ISO-23953:
 - H1: +1°+10°C, suitable for fruits and vegetables
- Climatic class 3 (25°C, 60 H.R)
- Pre-installation models incorporate solenoid and expansion valves in R-449A, option R-134a (consult other refrigerants)
- Injected polyurethane insulation, density 40kg / m³ low GWP and zero ODP effect

Modelo	decoración FRONTAL FRONT decor		decoración TOTAL FRONT decor		Juego costados cerrados	Juego costados panorámico	Tope estante metacrilato	Paragolpes tubo Inox	Iluminación LED X nivel estantes	Pre Instalación
Model	normal	alto brillo glossy	normal	alto brillo glossy	Blind sides SET	Panoramic sides SET	Methacrylate shelf stopper	Stainless steel bumper	LED Lighting X shelves level	Remote Unit
					LC	LE	ud	ud		
CDG / CDS 06	248 €	consultar	441 €	consultar	0 €	933 €	incluido	41 €	39 €	-166 €
CDG / CDS 09	258 €	consultar	449 €	consultar	0 €	933 €	incluido	59 €	58 €	-223 €
CDG / CDS 12	272 €	consultar	456 €	consultar	0 €	933 €	incluido	75 €	75 €	-275 €
CDG / CDS 15	282 €	consultar	462 €	consultar	0 €	933 €	incluido	88 €	80 €	-286 €
CDG / CDS 18	302 €	consultar	469 €	consultar	0 €	933 €	incluido	108 €	112 €	-327 €
CDG / CDS 25	312 €	consultar	475 €	consultar	0 €	933 €	incluido	137 €	181 €	-530 €
CDG 31	356 €	consultar	480 €	consultar	0 €	933 €	incluido	175 €	187 €	-733 €

Precio para opcionales montados en fábrica, no repuestos. Otros gases o voltajes, consultar

Price for factory-assembled options, not as spare parts. Other gases or voltages, consult

Vitrina expositora MURAL FRUTAS Y VERDURAS CON PUERTAS

FRUITS & VEGETABLES MULTIDECK display WITH DOORS



CDG



ESTANDAR
Total exterior GRIS 7024
Total grey exterior 7024



EXCEPCIONES - SPECIAL PRICE
Total exterior blanco o negro, incluido en precio estándar
Total exterior white or black included on standard price



Led vertical incluido en precio
Vertical led included in price



CDG1 18 H1 - LE
Decoración exterior, opcional
Optional exterior decoration



Lateral ABS de serie
ABS side as standard

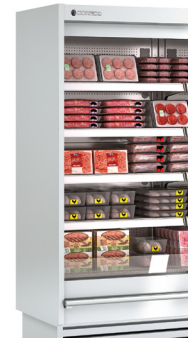

Lateral CERRADO -LC opcional
incluido en el precio
BLIND side -LC on demand
included on price



Lateral PANORÁMICO -LE opcional
con incremento
PANORAMIC side -LE on demand
with extra price

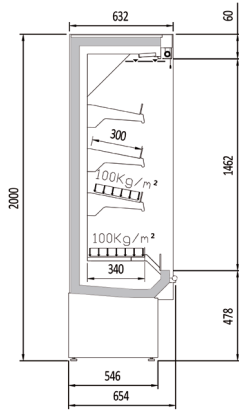

CDS0 06 H1	2.907 €
CDS0 09 H1	3.432 €
CDS0 12 H1	3.820 €
CDS0 15 H1	4.733 €
CDS0 18 H1	5.274 €
CDS0 25 H1	5.820 €

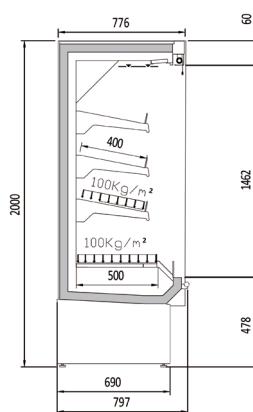

CDS1 06 H1	2.963 €
CDS1 09 H1	3.478 €
CDS1 12 H1	3.889 €
CDS1 15 H1	4.795 €
CDS1 18 H1	5.325 €
CDS1 25 H1	5.923 €

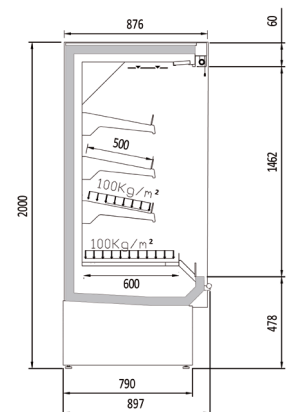

CDS3 06 H1	3.122 €
CDS3 09 H1	3.637 €
CDS3 12 H1	4.049 €
CDS3 15 H1	5.062 €
CDS3 18 H1	5.463 €
CDS3 25 H1	6.080 €

Modelo	Longitud (con costados)	Área estantes refrigerados m²			Superficie total exposición (TDA)			Volumen neto (L)			Estantes	Puertas	Potencia frigorífica	Consumo nominal	Refrigerante
Model	Length (with sides)	Refrigerated shelf area m²			Total display area (TDA)			Net volume (L)			Shelves	Doors	Cooling capacity	Nominal Power	Refrigerant
	(mm)	Fondo/Depth 0	Fondo/Depth 1	Fondo/Depth 3	Fondo/Depth 0	Fondo/Depth 1	Fondo/Depth 3	Fondo/Depth 0	Fondo/Depth 1	Fondo/Depth 3	Uds	Uds. Units	(W)	(W)	
CDS 06 H1	685	0,81	1,08	1,33	0,83	0,86	0,89	239	336	403	3	0	1192	1382	R290
CDS 09 H1	998	1,21	1,62	2,00	1,25	1,3	1,32	368	516	619	3	0	1528	1713	R290
CDS 12 H1	1310	1,61	2,16	2,66	1,62	1,7	1,73	480	671	805	3	0	1931	1885	R290
CDS 15 H1	1623	2,02	2,70	3,33	2,01	2,08	2,14	628	879	1055	6	0	2384	2368	R290
CDS 18 H1	1935	2,42	3,24	4,00	2,48	2,56	2,61	737	1032	1238	6	0	3056	3026	R290
CDS 25 H1	2560	3,23	4,33	5,33	3,18	3,36	3,42	959	1342	1611	6	0	3862	3770	R290

características técnicas y constructivas sujetas a variación sin previo aviso

we reserve the right to change specifications without prior notice

- Cortina de noche manual y frente cuba inferior de metacrilato
- Costados de 30 mm, de serie en ABS color gris RAL 7024, opcional CERRADO al mismo precio
- Costado panorámico (doble cristal) opcional con incremento de precio
- Interior: Blanco RAL 9003 o negro RAL 9005 incluidos en el precio
- Exterior: Blanco RAL 9003, negro RAL 9005 o gris RAL 7024 incluidos en el precio
- Decoración opcional, según costados, sólo frontal (franja superior e inferior) o total a elegir en los colores disponibles
- Espejo en la parte superior y tope frontal metacrilato en los estantes, de serie
- Evaporador ventilado con recubrimiento EPOXI anticorrosión
- Estantes regulables en altura y ángulo, con portaprecios de 40 mm incluidos
- Desescarche natural del evaporador con bandeja de evaporación automática
- Control electrónico
- Ventiladores electromecánicos, opcional electrónicos (consultar)
- Iluminación LED 24v 4000k
- Temperatura de producto, según EN-ISO-23953:
 - H1: +1*+10°C, apropiado para frutas y verduras
- Clase climática 3 (25°C, 60 H.R)
- Modelos preinstalación incorporan valvulería solenoide y expansión en R-449A, opción R-134a (consultar otros refrigerantes)
- Aislamiento de poliuretano inyectado, densidad 40kg/m3 bajo GWP y cero efecto ODP

- Manual night blind and inferior exposition deck perspex
- 30 mm sides, standard in gray ABS RAL 7024, optional BLIND at the same price
- Panoramic side (double glass) optional with price increase
- Interior: white RAL 9003 or black RAL 9005 included in price
- Exterior: white RAL 9003, black RAL 9005 or grey RAL 7024 included in price
- Optional decoration, depending on the sides, only front (upper and lower strip) or total to choose in the available colors.
- Mirror on the top and methacrylate front stop on the shelves, standard
- Ventilated evaporator EPOXY with anticorrosive coating
- Natural defrost of evaporator with automatic evaporation tray
- Electromechanic fans
- Electromechanic fans, on demand, electronics (consult)
- Electronic control
- 24v LED 4000k lighting
- Product temperature, according to EN-ISO-23953:
 - H1: +1*+10°C, suitable for fruits and vegetables
- Climatic class 3 (25°C, 60 H.R)
- Pre-installation models incorporate solenoid and expansion valves in R-449A, option R-134a (consult other refrigerants)
- Injected polyurethane insulation, density 40kg/ m3 low GWP and zero ODP effect

Modelo	decoración FRONTAL FRONT decor		decoración TOTAL FRONT decor		Juego costados cerrados	Juego costados panorámico	Tope estante metacrilato	Paragolpes tubo inox	Iluminación LED X nivel estantes	Pre Instalación
Model	normal	alto brillo glossy	normal	alto brillo glossy	Blind sides SET	Panoramic sides SET	Methacrylate shelf stopper	Stainless steel bumper	LED Lighting X shelves level	Remote Unit
					LC	LE	ud	ud		
CDG / CDS 06	248 €	consultar	441 €	consultar	0 €	933 €	incluido	41 €	39 €	-166 €
CDG / CDS 09	258 €	consultar	449 €	consultar	0 €	933 €	incluido	59 €	58 €	-223 €
CDG / CDS 12	272 €	consultar	456 €	consultar	0 €	933 €	incluido	75 €	75 €	-275 €
CDG / CDS 15	282 €	consultar	462 €	consultar	0 €	933 €	incluido	88 €	80 €	-286 €
CDG / CDS 18	302 €	consultar	469 €	consultar	0 €	933 €	incluido	108 €	112 €	-327 €
CDG / CDS 25	312 €	consultar	475 €	consultar	0 €	933 €	incluido	137 €	181 €	-530 €
CDG 31	356 €	consultar	480 €	consultar	0 €	933 €	incluido	175 €	187 €	-733 €

Precio para opcionales montados en fábrica, no repuestos. Otros gases o voltajes, consultar

Price for factory-assembled options, not as spare parts. Other gases or voltages, consult

Vitrina expositora MURAL FRUTAS Y VERDURAS

FRUITS & VEGETABLES MULTIDECK display



CDS



ESTANDARD

Total exterior GRIS 7024
Total grey exterior 7024



EXCEPCIONES - SPECIAL PRICE

Total exterior blanco o negro, incluido en precio estándar
Total exterior white or black included on standard price



CDS3 18 H1

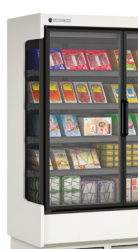

Lateral ABS de serie
ABS side as standard



Lateral CERRADO -LC opcional
incluido en el precio
BLIND side -LC on demand
included on price



Lateral PANORÁMICO -LE opcional
con incremento
PANORAMIC side -LE on demand
with extra price

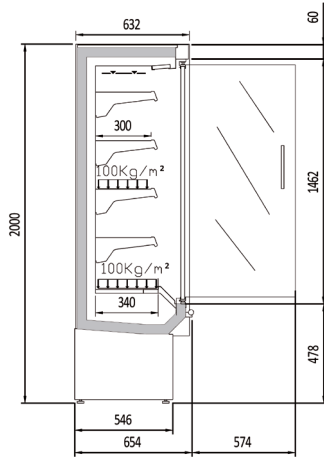

CDG0 06 I M	4.106 €
CDG0 09 I M	4.811 €
CDG0 12 I M	5.276 €
CDG0 15 I M	5.958 €
CDG0 18 I M	6.156 €
CDG0 25 I M	8.953 €

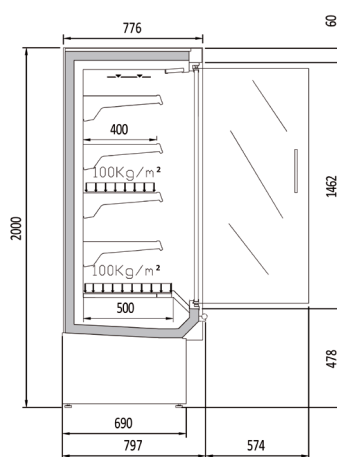

CDG1 06 I M	4.359 €
CDG1 09 I M	5.110 €
CDG1 12 I M	5.606 €
CDG1 15 I M	6.646 €
CDG1 18 I M	7.444 €
CDG1 25 I M	9.276 €

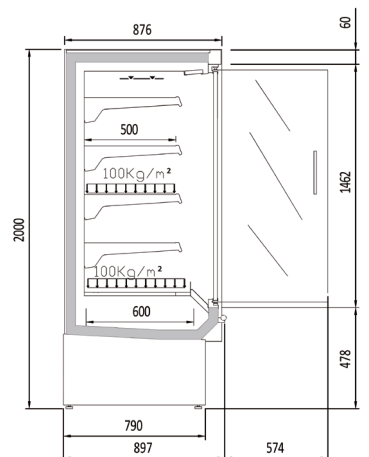

CDG3 06 I M	4.542 €
CDG3 09 I M	5.335 €
CDG3 12 I M	5.908 €
CDG3 15 I M	6.823 €
CDG3 18 I M	7.744 €
CDG3 25 I M	9.443 €

Modelo	Longitud (con costados)	Área estantes refrigerados m2			Superficie total exposicion (TDA)			Volumen neto (L)			Estantes	Potencia frigorífica	Consumo nominal	Refrigerante
Model	Length (with sides)	Refrigerated shelf area m2			Total display area (TDA)			Net volume (L)			Shelves	Cooling capacity	Nominal Power	Refrigerant
	(mm)	Fondo/Depth 0	Fondo/Depth 1	Fondo/Depth 3	Fondo/Depth 0	Fondo/Depth 1	Fondo/Depth 3	Fondo/Depth 0	Fondo/Depth 1	Fondo/Depth 3	Uds.	(W)	(W)	HC
CDG 06 M1-M2	685	1,00	1,34	1,65	0,73	0,76	0,78	255	357	428	4	555	1132	R-290
CDG 09 M1-M2	998	1,50	2,00	2,47	1,11	1,15	1,17	392	549	659	4	1192	1494	R-290
CDG 12 M1-M2	1310	2,00	2,68	3,30	1,46	1,5	1,52	510	714	857	4	1192	1508	R-290
CDG 15 M1-M2	1623	2,50	3,34	4,12	1,77	1,83	1,88	668	935	1122	8	1419	1635	R-290
CDG 18 M1-M2	1935	3,00	4,01	4,95	2,19	2,24	2,29	784	1098	1317	8	1528	1945	R-290
CDG 25 M1-M2	2560	4,00	5,35	6,60	2,9	2,94	2,99	1020	1428	1714	8	2384	2612	R-290

características técnicas y constructivas sujetas a variación sin previo aviso

we reserve the right to change specifications whitout prior notice

- Puertas abatibles de vidrio con serigrafía, apertura hasta 93° y bloqueo de cierre manual. Autocierra por barra de torsión
- Costados de 30 mm, de serie diseño CERRADO, opcional VISION
- Exterior e interior en acero inox
- Evaporador ventilado con recubrimiento EPOXI anticorrosión
- Estantes regulables en altura y ángulo, con portaprecios de 40 mm incluidos
- Desescarche natural del evaporador con bandeja de evaporación automática
- Ventiladores electromecánicos, opcional electrónicos (consultar)
- Control electrónico
- Iluminación LED 24v 4000k
- Temperatura de producto, según EN-ISO-23953:
M1: -1°+5°C, apropiado para carnes.
M2: -1°+7°C, apropiado para lácteos, delis y embutidos
- Clase climática 3 (25°C, 60 H.R)
- Modelos preinstalación incorporan valvulería solenoide y expansión en R-449A, opción R-134a (consultar otros refrigerantes)
- Aislamiento de poliuretano inyectado, densidad 40kg/m3 bajo GWP y cero efecto ODP

- Frameless hinged doors with complete glazed frontal with serigraphy, max opening 93° with manual blocking closure. Self-closing with torsion bar,
- 30 mm sides, as standard CLOSED design, optional VISION at same price
- Exterior and interior in stainless steel
- Ventilated evaporator EPOXY with anticorrosive coating
- Adjustable shelves in height and angle, with 40 mm price holders included
- Natural defrost of evaporator with automatic evaporation tray
- Electromechanic fans, on demmand, electronics (consult)
- Electronic control
- 24v LED 4000k lighting
- Product temperature, according to EN-ISO-23953:
M1: -1°+5°C, suitable for meat
M2: -1°+7°C, suitable for dairy products, delis and sausages
- Climatic class 3 (25°C, 60 H.R)
- Pre-installation models incorporate solenoid and expansion valves in R-449A, option R-134a (consult other refrigerants)
- Injected polyurethane insulation, density 40kg / m3 low GWP and zero ODP effect

Modelo	Juego costados VISION	Tope estante metacrilato	Paragolpes tubo inox	Iluminación LED X nivel estantes	Pre Instalación
Model	VISION sides SET	Methacrylate shelf stopper	Stainless steel bumper	LED Lighting X shelves level	Remote Unit
	LV	ud	ud		
CDG / CDS 06	0 €	30 €	41 €	39 €	-166 €
CDG / CDS 09	0 €	35 €	59 €	58 €	-223 €
CDG / CDS 12	0 €	38 €	75 €	75 €	-275 €
CDG / CDS 15	0 €	40 €	88 €	80 €	-286 €
CDG / CDS 18	0 €	56 €	108 €	112 €	-327 €
CDG / CDS 25	0 €	66 €	137 €	181 €	-530 €

Precio para opcionales montados en fábrica, no repuestos. Otros gases o voltajes, consultar

Price for factory-assembled options, not as spare parts. Other gases or voltages, consult

Vitrina expositora ACERO INOX CON PUERTAS SS MULTIDECK display WITH DOORS



CDG



Led vertical incluido
en precio
Vertical led included
in price



Lateral CERRADO -LC de serie
BLIND side -LC as standard



Lateral VISION -LV opcional
VISION side - LV on demand



CDG3 12 M1-M2 INOX
Costados VISION y paragolpes opcionales
VISION sides and bumper as extra

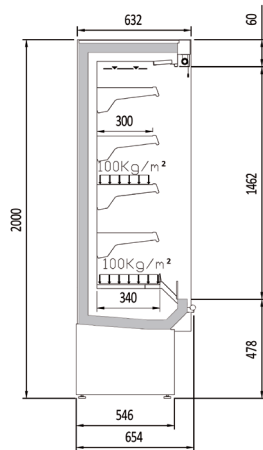

CDS0 06 I M1	3.189 €
CDS0 09 I M1	3.642 €
CDS0 12 I M1	4.257 €
CDS0 15 I M1	5.042 €
CDS0 18 I M1	5.700 €
CDS0 25 I M1	7.088 €

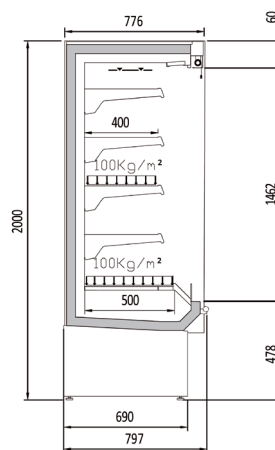

CDS1 06 I M1	3.460 €
CDS1 09 I M1	3.951 €
CDS1 12 I M1	4.618 €
CDS1 15 I M1	5.470 €
CDS1 18 I M1	6.290 €
CDS1 25 I M1	7.691 €

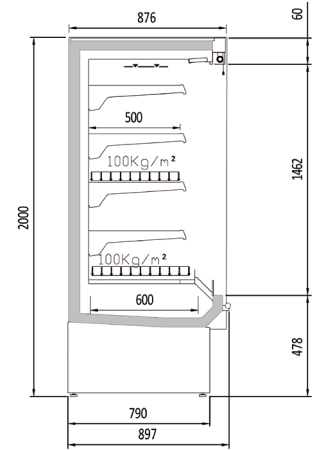

CDS3 06 I M1	3.708 €
CDS3 09 I M1	4.151 €
CDS3 12 I M1	4.850 €
CDS3 15 I M1	5.578 €
CDS3 18 I M1	6.545 €
CDS3 25 I M1	7.804 €

Modelo	Longitud (con costados)	Área estantes refrigerados m2	Superficie total exposición (TDA)			Volumen neto (L)			Estantes	Potencia frigorífica	Consumo nominal	Refrigerante		
Model	Length (with sides)	Refrigerated shelf area m2	Total display area (TDA)			Net volume (L)			Shelves	Cooling capacity	Nominal Power	Refrigerant		
	(mm)	Fondo/Depth 0	Fondo/Depth 1	Fondo/Depth 3	Fondo/Depth 0	Fondo/Depth 1	Fondo/Depth 3	Fondo/Depth 0	Fondo/Depth 1	Fondo/Depth 3	Uds	(W)	(W)	
CDS 06 M1-M2	685	1,00	1,34	1,65	0,84	0,87	0,9	255	357	428	4	1192	1362	R-290
CDS 09 M1-M2	998	1,50	2,00	2,47	1,27	1,32	1,34	392	549	659	4	1528	1713	R-290
CDS 12 M1-M2	1310	2,00	2,68	3,30	1,64	1,72	1,75	510	714	857	4	1931	1885	R-290
CDS 15 M1-M2	1623	2,50	3,34	4,12	2,03	2,1	2,16	668	935	1122	8	2384	2368	R-290
CDS 18 M1-M2	1935	3,00	4,01	4,95	2,5	2,58	2,63	784	1098	1317	8	3056	3026	R-290
CDS 25 M1-M2	2560	4,00	5,35	6,60	3,2	3,38	3,44	1020	1428	1714	8	3862	3770	R-290

características técnicas y constructivas sujetas a variación sin previo aviso

we reserve the right to change specifications whitout prior notice

- Cortina de noche manual y frente cuba inferior de metacrilato
- Costados de 30 mm, de serie diseño VISION, opcional CERRADO al mismo precio
- Exterior e interior en acero inox
- Evaporador ventilado con recubrimiento EPOXI anticorrosión
- Estantes regulables en altura y ángulo, con portaprecios de 40 mm incluidos
- Desescarche natural del evaporador con bandeja de evaporación automática
- Ventiladores electromecánicos, opcional electrónicos (consultar)
- Control electrónico
- Iluminación LED 24v 4000k
- Temperatura de producto, según EN-ISO-23953:
 - M1: -1°+5°C, apropiado para carnes.
 - M2: -1°+7°C, apropiado para lácteos, delis y embutidos
- Clase climática 3 (25°C, 60 H.R)
- Modelos preinstalación incorporan valvulería solenoide y expansión en R-449A, opción R-134a (consultar otros refrigerantes)
- Aislamiento de poliuretano inyectado, densidad 40kg/m3 bajo GWP y cero efecto ODP
- El paragolpes de tubo es opcional en todos los modelos (no incluido de serie)

- Manual night blind and and inferior exposition deck perspex
- 30 mm sides, as standard VISION design, optional CLOSED at same price
- Exterior and interior in stainless steel
- Ventilated evaporator EPOXY with anticorrosive coating
- Adjustable shelves in height and angle, with 40 mm price holders included
- Natural defrost of evaporator with utomatic evaporation tray
- Electromechanic fans, on demand, electronics (consult)
- Electronic control
- 24v LED 4000k lighting
- Product temperature, according to EN-ISO-23953:
 - M1: -1°+5°C, suitable for meat
 - M2: -1°+7°C, suitable for dairy products, delis and sausages
- Climatic class 3 (25°C, 60 H.R)
- Pre-installation models incorporate solenoid and expansion valves in R-449A, option R-134a (consult other refrigerants)
- Injected polyurethane insulation, density 40kg / m3 low GWP and zero ODP effect
- The tube bumper is optional on all models (not included as standard)

Modelo	Juego costados VISION	Tope estante metacrilato	Paragolpes tubo inox	Iluminación LED X nivel estantes	Pre Instalación
Model	VISION sides SET	Methacrylate shelf stopper	Stainless steel bumper	LED Lighting X shelves level	Remote Unit
	LV	ud	ud		
CDG / CDS 06	0 €	30 €	41 €	39 €	-166 €
CDG / CDS 09	0 €	35 €	59 €	58 €	-223 €
CDG / CDS 12	0 €	38 €	75 €	75 €	-275 €
CDG / CDS 15	0 €	40 €	88 €	80 €	-286 €
CDG / CDS 18	0 €	56 €	108 €	112 €	-327 €
CDG / CDS 25	0 €	66 €	137 €	181 €	-530 €

Precio para opcionales montados en fábrica, no repuestos.
Otros gases o voltajes, consultar

Price for factory-assembled options, not as spare parts.
Other gases or voltages, consult



CDS



Lateral CERRADO -LC de serie
BLIND side -LC as standard



Lateral VISION -LV opcional
VISION side -LV on demand



CDS1 250 M1-M2 INOX

Costados VISION opcionales
VISION sides as extra

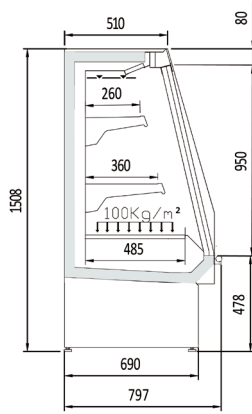

CSVG1 09 M1	4.311 €
CSVG1 12 M1	4.576 €
CSVG1 18 M1	5.685 €

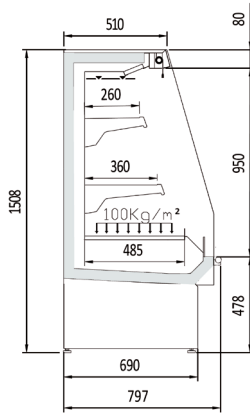

CSVS1 06 M2	2.580 €
CSVS1 09 M2	2.990 €
CSVS1 12 M2	3.165 €
CSVS1 15 M2	4.035 €
CSVS1 18 M2	4.055 €

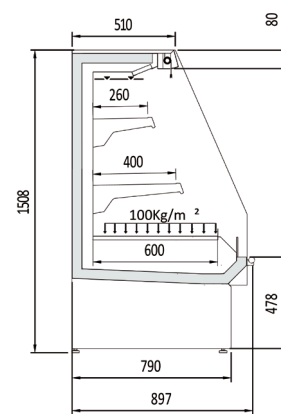

CSVS3 06 M2	2.630 €
CSVS3 09 M2	3.005 €
CSVS3 12 M2	3.300 €
CSVS3 15 M2	3.941 €
CSVS3 18 M2	4.072 €

Modelo	Longitud (sin costados) mm	Área estantes refrigerados m2	Superficie total exposicion (TDA)	Volumen neto (L)	Estantes (Uds.)	Puertas (Uds.)	Potencia frigorifica (W)	Consumo nominal (W)	Refrigerante
Model	Length (without sides) mm	Refrigerated shelf area m2	Total display area (TDA)	Net volume (L)	Shelves (units)	Doors (units)	Cooling capacity (W)	Nominal power (W)	Refrigerant
MODELOS CON PUERTAS / MODELS WITH DOORS									
CSVG1 09 M1	998	1,01	0,79	330	2	2	1192	1557	R290
CSVG1 12 M1	1310	1,35	1,09	421	2	2	1192	1639	R290
CSVG1 18 M1	1935	2,02	1,64	662	4	3	1528	1945	R290
MODELOS SIN PUERTAS / MODELS WITHOUT DOORS									
CSVS1 06 M2	685	0,67	0,57	212	2	-	1192	1382	R290
CSVS1 09 M2	998	1,01	0,8	330	2	-	1528	1713	R290
CSVS1 12 M2	1310	1,35	1,1	421	2	-	1931	1885	R290
CSVS1 15 M2	1623	1,69	1,35	564	4	-	2384	2368	R290
CSVS1 18 M2	1935	2,02	1,66	662	4	-	3056	3026	R290
CSVS3 06 M2	685	0,77	0,61	254	2	-	1192	1382	R290
CSVS3 09 M2	998	1,15	0,9	396	2	-	1528	1713	R290
CSVS3 12 M2	1310	1,54	1,21	505	2	-	1931	1885	R290
CSVS3 15 M2	1623	1,92	1,52	677	4	-	2384	2368	R290
CSVS3 18 M2	1935	2,32	1,81	794	4	-	3056	3026	R290

características técnicas y constructivas sujetas a variación sin previo aviso

we reserve the right to change specifications without prior notice

- Modelo CSVS: Cortina de noche manual y frente cuba inferior de metacrilato
- Modelo CSVG: Puertas cristal sobre marco deslizante, reduce el consumo energético
- Costados espesor 30mm diseño PANORAMICO
- Interior: Blanco RAL 9003 o negro RAL 9005 incluidos en el precio
- Exterior: Blanco RAL 9003, negro RAL 90005 o gris RAL 7024 incluidos en el precio
- Evaporador ventilado con recubrimiento EPOXI anticorrosión
- Estantes regulables en altura y ángulo, con portaprecios de 40 mm incluidos
- Desescarche natural del evaporador con bandeja de evaporación automática
- Ventiladores electromecánicos, opcional electrónicos (consultar)
- Control electrónico
- Iluminación LED 24v 4000k
- Temperatura de producto, según EN-ISO-23953:
 - CSVG: M1 -1°+5°C, apropiado para carnes.
 - CSVS: M2 -1°+7°C, apropiado para lácteos, delis y embutidos
- Clase climática 3 (25°C, 60 H.R)
- Modelos preinstalación incorporan valvulería solenoide y expansión en R-449A, opción R-134a (consultar otros refrigerantes)
- Aislamiento de poliuretano inyectado, densidad 40kg/m3 bajo GWP y cero efecto ODP
- El paragolpes de tubo es opcional en todos los modelos (no incluido de serie)

- CSVS Model: Manual night blind and inferior exposition deck perspex
- CSVG Model: Glazed sliding doors, reduce energy consumption
- 30 mm sides, PANORAMIC DESIGN
- Interior: white RAL 9003 or black RAL 9005 included in price
- Exterior: white RAL 9003, black RAL 9005 or grey RAL 7024 included in price
- Ventilated evaporator EPOXY with anticorrosive coating
- Adjustable shelves in height and angle, with 40 mm price holders included
- Natural defrost of evaporator with automatic evaporation tray
- Electromechanic fans, on demand, electronics (consult)
- Electronic control
- 24v LED 4000k lighting
- Product temperature, according to EN-ISO-23953:
 - CSVG: M1 -1°+5°C, suitable for meat
 - CSVS: M2 -1°+7°C, suitable for dairy products, delis and sausages
- Climatic class 3 (25°C, 60 H.R)
- Pre-installation models incorporate solenoid and expansion valves in R-449A, option R-134a (consult other refrigerants)
- Injected polyurethane insulation, density 40kg/ m3 low GWP and zero ODP effect
- The tube bumper is optional on all models (not included as standard)

Modelo	decoración FRONTAL FRONT decor		decoración TOTAL FRONT decor		Topo estante metacrilato	Paragolpes tubo inox	Iluminación LED X nivel estantes	Pre Instalación
Model					Methacrylate shelf stopper	Stainless steel bumper	LED Lighting X shelves level	Remote Unit
	normal	alto brillo glossy	normal	alto brillo glossy	ud	ud		
SVS 06	248 €	consultar	441 €	consultar	30 €	41 €	39 €	-166 €
SVS / SVG 09	258 €	consultar	449 €	consultar	35 €	59 €	58 €	-223 €
SVS / SVG 12	272 €	consultar	456 €	consultar	38 €	75 €	75 €	-275 €
SVS 15	282 €	consultar	462 €	consultar	40 €	88 €	80 €	-286 €
SVS / SVG 18	302 €	consultar	469 €	consultar	56 €	108 €	112 €	-327 €

Precio para opcionales montados en fábrica, no repuestos.
Otros gases o voltajes, consultar

Price for factory-assembled options, not as spare parts.
Other gases or voltages, consult

Vitrina expositora MURAL BAJA

LOW HEIGHT MULTIDECK display



ESTANDARD

Total exterior GRIS 7024
Total grey exterior 7024

EXCEPCIONES - SPECIAL PRICE

Total exterior blanco o negro, incluido en precio estándar
Total exterior white or black included on standard price



CSVG 12



Puertas correderas en modelos CSVG
Sliding doors on CSVG models

MURALES 9