



CORECO



VITRINAS y ARMARIOS AUXILIARES *AUXILIAR DISPLAYS and CABINETS*

TAPAS SUSHI

Pag. 404-409

Bandeja fria tapas
Tapas cooler display

Pag. 410-411

Bandeja fria sushi
Sushi cooler display

VITRINA CERRADAS - *VISION DISPLAY*

Pag. 412-413

Vitrina cerrada refrigerada 9
Vision display 9

Pag. 414-415

Vitrina refrigerada carro
Trolley refrigerated display



BT-6	1.300 €
BT-8	1.440 €



BT-6-R	1.248 €
BT-8-R	1.386 €

ref.	largo length (mm)	alto height (mm)	fondo depth (mm)	base platos dish area (mm)	motor remoto remote condenser unit	potencia frig. frig. power (W)	consumo consumption (W)	peso neto net weight (Kg)	tensión monofásica single phase voltage	refrigerante refrigerant
BT-6	1400	200	385	300x1030		190	143	33	230 V- 50 Hz	R290
BT-8	1750	200	385	300x1380		190	145	40	230 V- 50 Hz	R290
BT-6-R	1200	200	385	300x1030	incluido	190	143	48	230 V- 50 Hz	R290
BT-8-R	1550	200	385	300x1380	incluido	190	145	40	230 V- 50 Hz	R290

Características técnicas y constructivas sujetas a variación sin previo aviso.

- Exterior en acero inox AISI-304 18/10
- Fondo interior embutido en acero inox AISI 304 18/10
- Cristal curvo templado y securizado
- Iluminación interior por LEDS
- Puertas transparentes abatibles.
- Aislamiento de poliuretano inyectado, densidad 40 Kg/m³, cero efectos ODP y GWP
- Reguladores de altura
- Unidad condensadora ventilada, incluida en modelo remoto (2 metros), medidas (largo x alto x fondo) 310x240x360
- Ajuste de temperatura y descarche por control electrónico digital
- Temperatura de trabajo +4° +8° a 32°C de ambiente

Fondo plano, no GN 1/3

We reserve the right to change specifications without prior notice.

- AISI-304 18/10 stainless steel exterior
- AISI-304 18/10 stainless steel stamped bottom
- Toughened curved safety glass
- LED lighting
- Transparent front opening doors
- 40 Kg/m³ density polyurethane insulation, zero ODP and GWP
- Adjustable supports
- Fan assisted condenser unit, included in remote models (2 meters), measures (length x height x depth) 310x240x360
- Temperature and defrost sets by digital electronic control
- Operating temperature +4° +8° , 32°C ambient

Not GN 1/3 capacity

Opciones - Options

230v 60Hz / 115v 60Hz consultar - consult

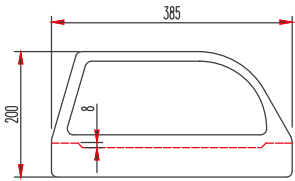

BT - 8



BT - 8 - R
unidad condensadora remota incluida
included remote condenser unit



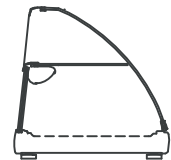
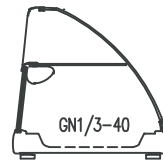
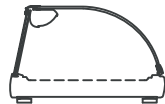
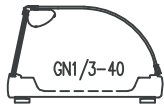

BCC-4-I	1.260 €	BCL-4-I	1.180 €	BCCD-6-I	1.577 €	BCLD-6-I	1.440 €
BCC-6-I	1.415 €	BCL-6-I	1.280 €	BCCD-8-I	1.703 €	BCLD-8-I	1.528 €
BCC-8-I	1.554 €	BCL-8-I	1.386 €				

Cubetas GN incluidas en el precio - GN containers included in price

ref.	largo length (mm)	alto height (mm)	fondo depth (mm)	base platos dish area (mm)	GN 1/3-40	potencia frig. frig. power (W)	consumo consumption (W)	tensión monofásica single phase voltage	refrigerante refrigerant
BCC-4	1050	255	410		4	190	138	230 V- 50 Hz	R290*
BCC-6	1400	255	410		6	190	143	230 V- 50 Hz	R290*
BCC-8	1755	255	410		8	190	145	230 V- 50 Hz	R290*
BCL-4	1050	255	410	300 x 675		190	138	230 V- 50 Hz	R290*
BCL-6	1400	255	410	300 x 1030		190	143	230 V- 50 Hz	R290*
BCL-8	1755	255	410	300 x 1380		190	145	230 V- 50 Hz	R290*
BCCD-6	1400	400	410		6	190	143	230 V- 50 Hz	R290*
BCCD-8	1750	400	410		8	190	145	230 V- 50 Hz	R290*
BCLD-6	1400	400	410	300 x 1030		190	143	230 V- 50 Hz	R290*
BCLD-8	1750	400	410	300 x 1380		190	145	230 V- 50 Hz	R290*

Características técnicas y constructivas sujetas a variación sin previo aviso.

- Exterior en acero inox AISI-304 18/10
- Fondo interior embutido en acero inox AISI 304 18/10
- Cristal curvo templado y securizado
- Puertas transparentes correderas
- BCCD y BCLD con estante superior no refrigerado
- Aislamiento de poliuretano inyectado, densidad 40 Kg/m³, cero efectos ODP y GWP
- Reguladores de altura
- Iluminación interior por LEDS
- Unidad condensadora ventilada
- Ajuste de temperatura y descarche por control electrónico digital
- Temperatura de trabajo +4° +8° a 32°C de ambiente

BCC- BCCD Bandeja interior embutida, preparada para cubetas GN1/3-40 (incluidas)

BCL- BCLD Bandeja interior embutida, preparada para platos (no incluidos)

We reserve the right to change specifications without prior notice.

- AISI-304 18/10 stainless steel exterior
- AISI-304 18/10 stainless steel stamped bottom
- Toughened curved safety glass
- Transparent sliding doors
- BCCD and BCLD with no refrigerated glass shelf
- 40 Kg/m³ density polyurethane insulation, zero ODP and GWP
- Adjustable supports
- Interior LEDS lighting
- Fan assisted condenser unit
- Temperature and defrost sets by digital electronic control
- Operating temperature +4° +8° , 32°C ambient

BCC - BCCD, stamped steel bottom, GN 1/3-40 containers capacity (included)

BCL - BCLD, stamped steel (not GN capacity)



BCCD - 8

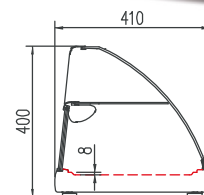
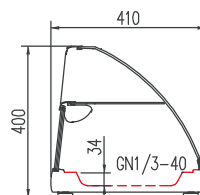
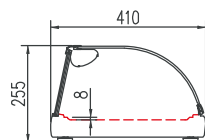
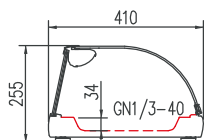

Opciones - Options

230v 60Hz / 115v 60Hz consultar - consult



BCC - 6



BCL - 6



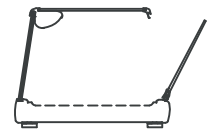
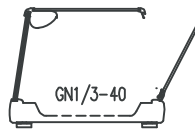
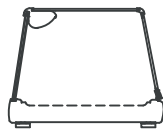
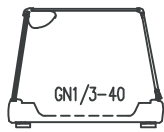

BPC-4-I	1.509 €
BPC-6-I	1.608 €
BPC-8-I	1.798 €

BPL-4-I	1.300 €
BPL-6-I	1.488 €
BPL-8-I	1.635 €

BPCA-6-I	1.716 €
BPCA-8-I	1.950 €

BPLA-6-I	1.622 €
BPLA-8-I	1.782 €

Cubetas GN incluidas en el precio - GN containers included in price

ref.	largo length (mm)	alto height (mm)	fondo depth (mm)	base platos dish area (mm)	GN 1/3-40	potencia frig. frig. power (W)	consumo consumption (W)	tensión monofásica single phase voltage	refrigerante refrigerant
BPC-4	1050	315	410		4	190	138	230 V- 50 Hz	R290
BPC-6	1400	315	410		6	190	143	230 V- 50 Hz	R290
BPC-8	1755	315	410		8	190	144	230 V- 50 Hz	R290
BPL-4	1050	315	410	300 x 675		190	138	230 V- 50 Hz	R290
BPL-6	1400	315	410	300x 1030		190	143	230 V- 50 Hz	R290
BPL-8	1755	315	410	300 x 1380		190	144	230 V- 50 Hz	R290
BPCA-6	1400	315	410		6	190	143	230 V- 50 Hz	R290
BPCA-8	1755	315	410		8	190	144	230 V- 50 Hz	R290
BPLA-6	1400	315	410	300 x 1030		190	143	230 V- 50 Hz	R290
BPLA-8	1755	315	410	300 x 1380		190	144	230 V- 50 Hz	R290

Características técnicas y constructivas sujetas a variación sin previo aviso.

- Exterior en acero inox AISI-304 18/10
- Fondo interior embutido en acero inox AISI 304 18/10
- Cristal plano templado y securizado
- Puertas transparentes correderas, en el lado de servicio
- Aislamiento de poliuretano inyectado, densidad 40 Kg/m³, cero efectos ODP y GWP
- Reguladores de altura
- Iluminación interior por LEDS
- Unidad condensadora ventilada
- Ajuste de temperatura y descarche por control electrónico digital
- Temperatura de trabajo +4° +8° a 32°C de ambiente

BPC- BPCA Bandeja interior embutida, preparada para cubetas GN1/3-40 (incluidas)

BPL- BPLA Bandeja interior embutida, preparada para platos (no incluidos)

We reserve the right to change specifications without prior notice.

- AISI-304 18/10 stainless steel exterior
- AISI-304 18/10 stainless steel stamped bottom
- Toughened safety glass
- Transparent sliding doors,
- 40 Kg/m³ density polyurethane insulation, zero ODP and GWP
- Adjustable supports
- Interior LEDS lighting
- Fan assisted condenser unit
- Temperature and defrost sets by digital electronic control
- Operating temperature +4° +8° , 32°C ambient

BPC - BPCA stamped steel bottom, GN 1/3-40 containers capacity (included)

BPL - BPLA stamped steel (not GN capacity)

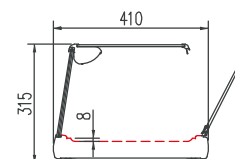
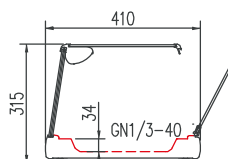
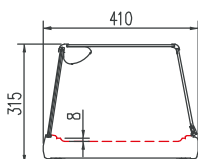
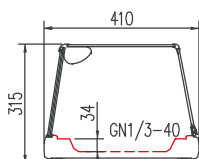

Opciones - Options

230v 60Hz / 115v 60Hz consultar - consult

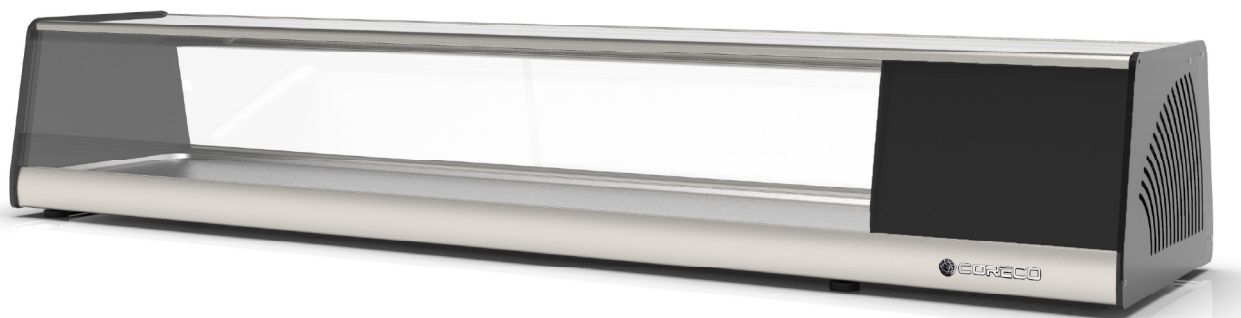

BPL - 8



BPCA - 8



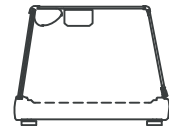
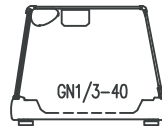
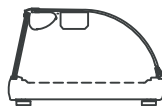
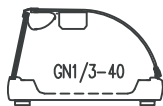

BCCS-4-I	1.583 €	BCS-4-I	1.500 €	BPCS-4-I	1.857 €	BPS-4-I	1.683 €
BCCS-6-I	1.756 €	BCS-6-I	1.629 €	BPCS-6-I	1.984 €	BPS-6-I	1.837 €
BCCS-8-I	1.924 €	BCS-8-I	1.770 €	BPCS-8-I	2.204 €	BPS-8-I	2.057 €

Cubetas GN incluidas en el precio - GN containers included in price

ref.	largo length (mm)	alto height (mm)	fondo depth (mm)	base platos dish area (mm)	GN 1/3-40	potencia frig. frig. power (W)	consumo consumption (W)	tensión monofásica single phase voltage	refrigerante refrigerant
BCCS-4	1050	255	410		4	190	138	230 V- 50 Hz	R290
BCCS-6	1400	255	410		6	210	146	230 V- 50 Hz	R290
BCCS-8	1755	255	410		8	225	152	230 V- 50 Hz	R290
BCS-4	1050	255	410	300 x 675		190	138	230 V- 50 Hz	R290
BCS-6	1400	255	410	300 x 1030		210	146	230 V- 50 Hz	R290
BCS-8	1755	255	410	300 x 1380		225	152	230 V- 50 Hz	R290
BPCS-4	1050	315	410		4	190	138	230 V- 50 Hz	R290
BPCS-6	1400	315	410		6	210	146	230 V- 50 Hz	R290
BPCS-8	1775	315	410		8	225	152	230 V- 50 Hz	R290
BPS-4	1050	315	410	300 x 675		190	138	230 V- 50 Hz	R290
BPS-6	1400	315	415	300 x 1030		210	146	230 V- 50 Hz	R290
BPS-8	1775	315	415	300 x 1380		225	152	230 V- 50 Hz	R290

Características técnicas y constructivas sujetas a variación sin previo aviso.

- Exterior en acero inox AISI-304 18/10
- Fondo interior embutido en acero inox AISI 304 18/10
- Cristal curvo o plano templado y securizado
- Puertas transparentes correderas
- Aislamiento de poliuretano inyectado, densidad 40 Kg/m³, cero efectos ODP y GWP
- Reguladores de altura
- Iluminación interior por LEDS
- Unidad condensadora ventilada
- Ajuste de temperatura y descarche por control electrónico digital
- Temperatura de trabajo 0° +6° a 32°C de ambiente

BCCS- BPCS Bandeja interior embutida, preparada para cubetas GN1/3-40 (incluidas)

BCS- BPS Bandeja interior embutida, preparada para platos (no incluidos)

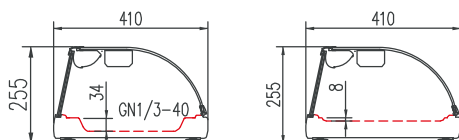

We reserve the right to change specifications without prior notice.

- AISI-304 18/10 stainless steel exterior
- AISI-304 18/10 stainless steel stamped bottom
- Toughened safety glass
- Transparent sliding doors
- 40 Kg/m³ density polyurethane insulation, zero ODP and GWP
- Adjustable supports
- Interior LEDS lighting
- Fan assisted condenser unit
- Temperature and defrost sets by digital electronic control
- Operating temperature 0° +6° , 32°C ambient

BCCS - BPCS, stamped steel bottom, GN 1/3-40 containers capacity (included)

BCS - BPS stamped steel (not GN capacity)

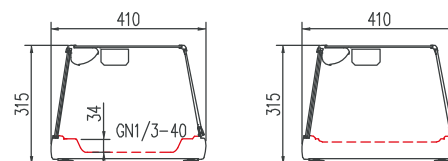

Opciones - Options

230v 60Hz / 115v 60Hz consultar - consult

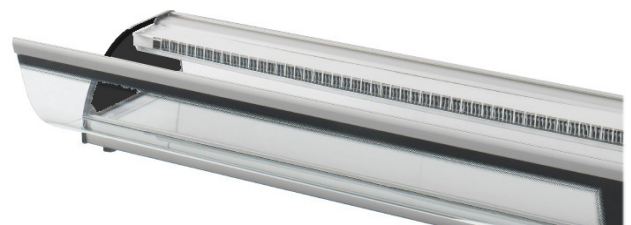

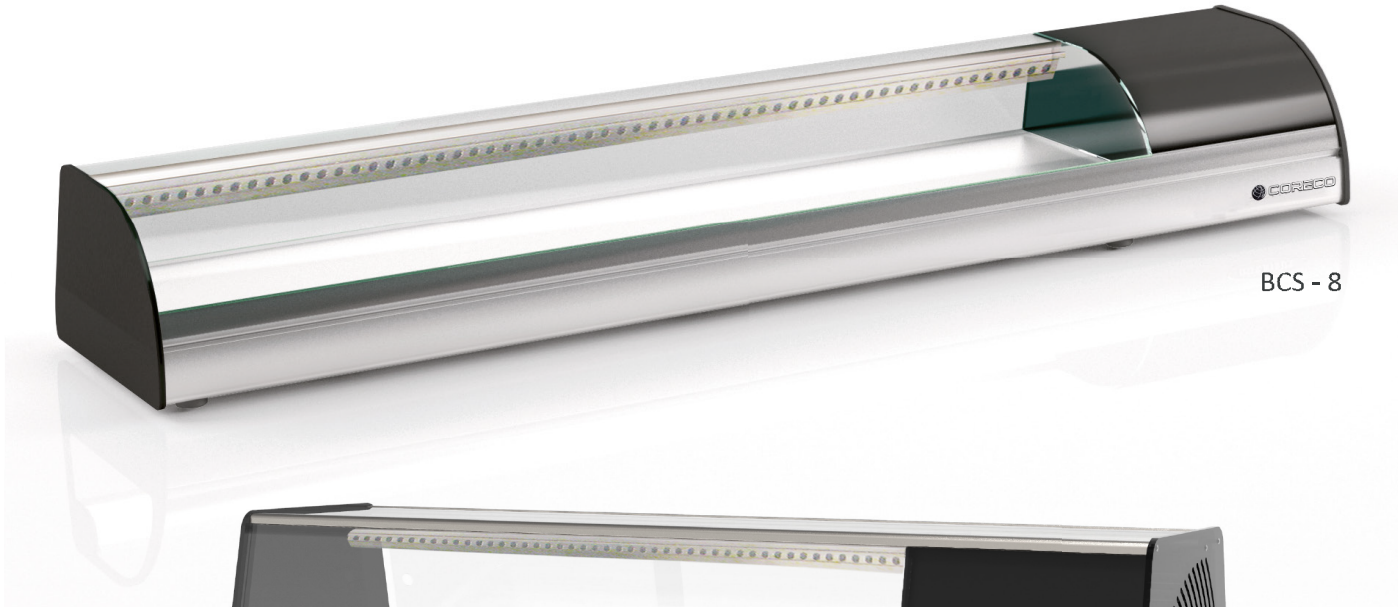

BCS - 8

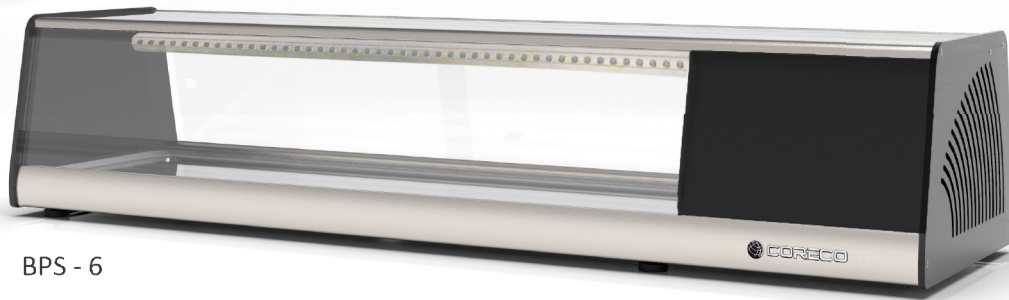

BPS - 6





CVCC-9-13 2.945 €



CVCC-9-15 3.035 €



CVCC-9-20 3.706 €

ref.	largo length (mm)	alto height (mm)	fondo depth (mm)	potencia frig. frig. power (W)	consumo consumption (W)	superficie estantes shelves area (m ²)	TDA (m ²)	puertas doors	tensión monofásica single phase voltage	refrigerante refrigerant	rango range
CVCC-9-13	1315	1085	850	781	417	1.83	0.37	2	230 V- 50 Hz	R290	+2°C+6°C
CVCC-9-15	1515	1085	850	781	418	2.11	0.43	2	230 V- 50 Hz	R290	+2°C+6°C
CVCC-9-20	2015	1085	850	949	485	2.84	0.59	3	230 V- 50 Hz	R290	+2°C+6°C

Características técnicas y constructivas sujetas a variación sin previo aviso.

- Exterior en acero inox AISI-304
- Interior en acero inox AISI-304
- Puertas con sistema de cierre automático y burlete magnético (permanece abierta al superar los 90° de apertura)
- Contrapuerta inox embutida
- Reguladores de altura
- Iluminación interior por LEDS
- Estantes interiores en acero plastificado
- Frontal abatible, cristal doble sobre marco de aluminio anodizado
- Evaporador estático con recubrimiento epoxi anticorrosión
- Unidad condensadora ventilada
- Evaporación automática del agua de descarche
- Aislamiento de poliuretano inyectado, densidad 40 Kg/m³, cero efectos ODP y GWP
- Control digital de temperatura y descarches, eficiente en la gestión del consumo de energía
- Temperatura de trabajo +2° +6° a 25°C ambiente

We reserve the right to change specifications without prior notice.

- AISI-304 stainless steel exterior
- AISI-304 stainless steel interior
- Doors with self closing system, blocked opening hinge and magnetic gasket
- Rear-door by stamped steel
- Adjustable supports
- Interior LEDS lighting
- Shelves made of plasticized steel wire
- Double glazed front opening side, with anodized aluminium frame.
- Static evaporator, with epoxi anticorrosion coating.
- Fan assisted condenser unit
- Automatic evaporation of defrost water
- 40 Kg/m³ density polyurethane insulation, zero ODP and GWP
- Energy efficient digital controller of temperature and defrosts
- Operating temperature +2° +6° , 25°C ambient

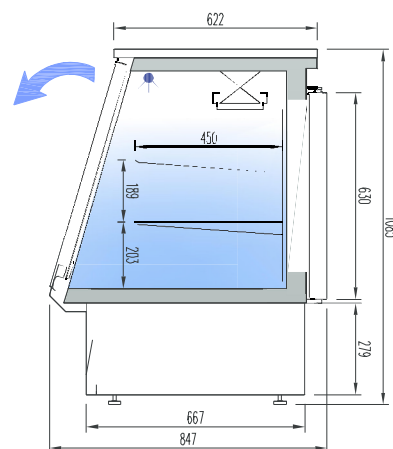

Opciones - Options

set 4 ruedas	4 castors set	240 € x set
puertas de cristal	glass doors	210 € x ud
230v 60Hz / 115v 60Hz	230v 60Hz / 115v 60Hz	consultar - consult



CVCC-9-20



CVCC-9-15
frontal abierto
front opened

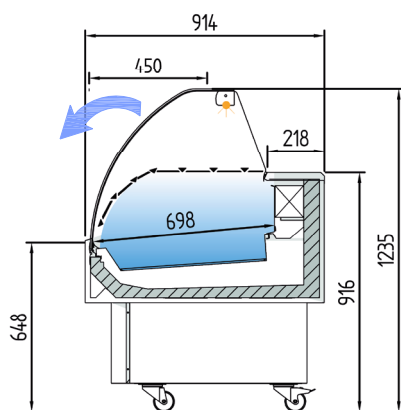

CEEC-100-CC-EF	2.845 €
CEEC-130-CC-EF	3.280 €
CEEC-150-CC-EF	3.610 €

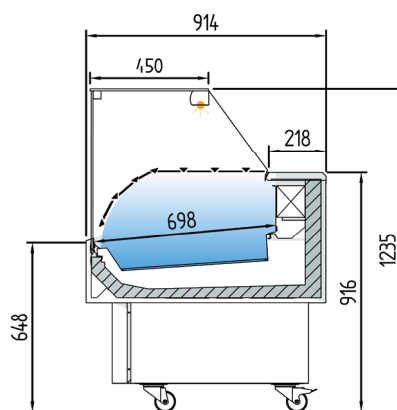

CEEC-100-RR-EF	2.830 €
CEEC-130-RR-EF	3.120 €
CEEC-150-RR-EF	3.274 €

ref.	largo length (mm)	superficie exposición display area (m ²)	exposición display TDA (m ²)	potencia frig. frig. power (W)	consumo consumption (W)	tensión monofásica single phase voltage	refrigerante refrigerant
CEEC-100-EF-CC / RR	1035	0,55	0,76	565	815	230V- 50Hz	R290
CEEC-130-EF-CC / RR	1285	0,70	0,95	781	991	230V- 50Hz	R290
CEEC-150-EF-CC / RR	1505	0.84	1.13	949	1064	230V- 50Hz	R290

Características técnicas y constructivas sujetas a variación sin previo aviso.

- Exterior en acero inox AISI-304
- Interior en acero inox AISI-304
- Cristal frontal templado y abatible
- Bastidor en acero acabado epoxi, sobre ruedas, 2 de ellas con freno
- Perfilera de aluminio anodizado
- Unidad condensadora ventilada
- Aislamiento de poliuretano inyectado, densidad 40 Kg/m³, bajo GWP y cero efecto ODP
- Control digital de temperatura y descarches, eficiente en la gestión del consumo de energía
- Temperatura de trabajo a 25°C 60% HR ambiente, clase climática 3
- EEC-EF evaporador estático + placa fría
- Cierre plexi de serie
- Iluminación LED superior

We reserve the right to change specifications without prior notice.

- AISI-304 stainless steel exterior
- AISI-304 stainless steel interior
- Toughened curved glass hinges forward
- Steel frame with epoxy finish, on wheels, 2 of them with brakes
- Anodized aluminium profiles
- Ventilated condenser unit
- 40 Kg/m³ density polyurethane insulation, low GWP and zero ODP effect
- Energy efficient digital controller of temperature and defrosts
- Operating temperature 25°C 60% HR ambient, climatic class 3
- EEC-EF, static evaporator + cool plate
- Plexi slide doors as standard
- Top LED lighting

Opciones - Options

	Cuerpo interior inox. AISI-316 AISI-316 Inner structure	Plano de exposición inox. AISI-316 AISI-316 Exhibition plan	Encimera inox. AISI-316 AISI-316 worktop	230v 60Hz / 115v 60Hz
CEEC-100	390 €	374 €	84 €	consultar - consult
CEEC-130	448 €	429 €	98 €	consultar - consult
CEEC-150	539 €	516 €	111 €	consultar - consult

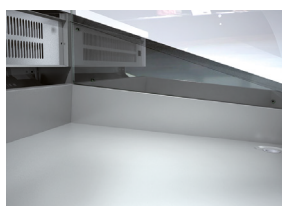
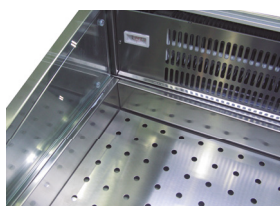

cristal abatible / liftable glass



desagües / drains





CEEC-150-CC-EF



CEEC-150-RR-EF